

*marten*  
furniture and interior fittings



*ma*

# Contents



1	Welcome	69	Brackets & Shelving
2	Placing Orders	71	Stays
3	Bespoke Manufacturing	72	Chest Handles
5	Arts & Crafts	73	Cardframes
7	Knobs	74	Logo Labels
13	Pull Handles	75	Catches & Table Fittings
18	Architectural Pull & Appliance Handles	79	Castors
19	Besanatech	85	Tray Handles
20	Hockley	86	Clock Fittings
21	Swarovski Elements	87	Hinges
23	Art Deco	91	Architectural Hinges
24	Art Nouveau	93	Door Knockers
25	Aston Cross	96	Ornamental
27	Warstone	99	Locks
29	Mission	104	Key Blanks
30	Hexagon Suite	105	Bolts
31	Cabinet Handles	106	Barrel Bolts
35	Edwardian Handles	107	Architectural Rim Locks
37	Oval Plate Handles	108	Architectural Door Furniture
40	Pedestal & Wardrobe Handles	109	Architectural Door Stops and Flush Handles
43	Plate Handles	110	Architectural Bolts
51	Ring Handles	111	Architectural Espagnolette Bolts
55	Drop Handles	113	General Information
60	Escutcheons & Covers	114	Finishes
65	Military & Marine Fittings	115	Terms & Conditions
67	Hooks		

# Welcome to our latest catalogue

Please spare a few moments to read some of the following information regarding ordering and dealing with Martins as we feel that this will help us to get your needs met promptly and accurately.

We have a hardworking and committed team who believe that only by providing you, the customer with great products, excellent service and fair prices can we all prosper.

If you have a question or special request, call us and we will try to accommodate your needs.



**Birmingham Chamber**  
of Commerce and Industry



# Placing orders



You can place orders by phone, fax, email or directly via our website. We can accept payments by cheque in Pounds, Euros and US Dollars along with all major credit and debit cards.

We also offer monthly credit accounts subject to references.

Our office hours are 8am to 5pm Monday to Thursday and 8am to 1pm Fridays.



# Bespoke Manufacturing

**The major strength of Martin being a member of the Armac Group is that it gives us the necessary skills and production capabilities to meet any requirements you might have. There is a wealth of knowledge and skills throughout the Group, which enables us to solve manufacturing problems and to produce components from designers' drawings and plans.**

At home in the Armac Brassworks factory we have the skills and experience available to provide brass manufacturing of the highest quality. We have our own brass presswork facility, we do our own brazing work, we can hand finish and polish all manner of brass components, and within our CNC engineering division we have invested over £1 million pounds in the very latest CNC turning and milling machines to enable us to produce complex components in-house. In addition to our own skills we are perfectly placed in Birmingham to source components and services from other local businesses which can provide us with;

- brass forging
- hot brass stamping
- brass pressure die-casting
- gravity casting
- sand casting
- lost-wax
- fine casting
- electro plating in Chrome and Nickel.

The list is endless, and you may be pleasantly surprised to find that unlike some of our overseas competition quantities don't necessarily need to be sky high and fill a container!

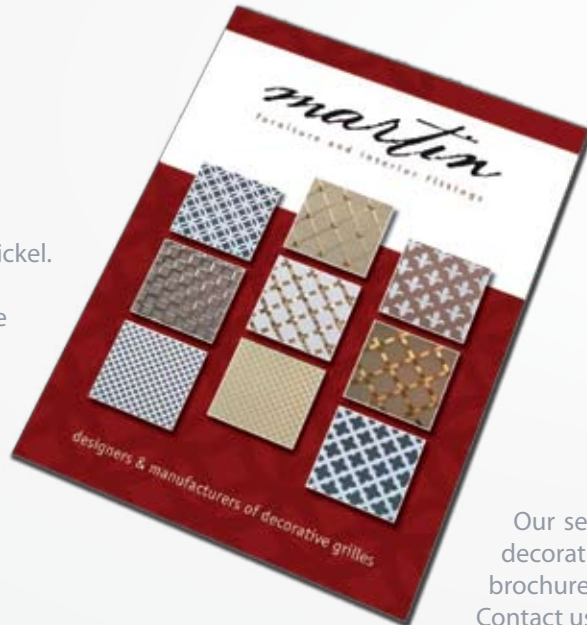

Our separate 64 page decorative grille colour brochure. Contact us for your copy.



We can produce one-off replacement parts, we can manage 10's or 20's for special projects, we major in the 100, 500, 1,000 batches, and are well set up to comfortably produce in the 10,000 unit arena if required to do so.

In recent times we have developed many exclusive items for key kitchen manufacturers both in the UK and in the USA, we work as production partners for some very high end lighting companies, we work with specialised boat builders, we provide parts for cooker and range manufacturers, we provide restoration assistance on English Heritage projects, and can supply a bolt for your garden gate!

In addition, we can provide laser etching to add logos and names to handles and knobs to provide branding and exclusivity to the finished product, be it a kitchen or contract furniture piece.

We also have a pattern vault crammed with old designs and patterns which we recourse to when we are looking for something a bit different to launch or to meet a specific enquiry from a furniture designer.

We have old catalogues and display boards that show all these products and we have in the past allowed furniture designers to browse through all the boxes of handles, plates, rings, drops and escutcheons. This helps them to finalise their designs and we can then begin to get prototypes made up for sample pieces of furniture.

We have our own designers and pattern makers so if you only have a rough idea of what you want to produce, we can work with you. Taking your ideas and rough sketches and working together producing what you had in mind.

Our aim is to make the Armac Group your first thought whenever you have a new product enquiry or building project that needs development.



# ARTS & CRAFTS

Arts & Crafts furniture fittings are very popular as we launch this catalogue in 2008 and there are many mass-produced versions on the market. However we believe that our range is pure Arts & Crafts because so much of it is hand-made and hand finished. It is solid and functional, yet beautiful and decorative.

William Morris, a founder of the Arts & Crafts Movement, once said "try to get the most from your material, but always in such a way as to honour it most".

We believe that we have done exactly that.



1 4064



2 4065



3 4066



4 4086



5 4085



6 4084

## 1 Forged Brass, Arts & Crafts style, Plate Handle

Finish: ANT

Code	Height	Width	Centre to Centre
4064	64mm	127mm	64mm

## 2 Forged Brass, Arts & Crafts style, Pedestal Pull Handle

Finish: ANT

Code	Height	Width
4065	108mm	38mm

## 3 Forged Brass, Arts & Crafts style, Plate Drop Handle

Finish: ANT

Code	Height	Width
4066	76mm	102mm

## 4 Forged Brass, Arts & Crafts style Cabinet Hinge

Finish: ANT

Code	Height	Width
4086	76mm	48mm

## 5 Sand Cast Brass, Arts & Crafts style, Escutcheon

Finish: ANT

Code	Height	Width
4085	25mm	32mm

## 6 Forged Brass, Arts & Crafts style Cabinet Handle (Sand Cast Rosettes)

Finish: ANT

Code	Height	Width	Centre to Centre
4084	45mm	102mm	64mm



**1 Mackintosh Design Pull Handle – Holy Island 1901**

Finish: ANT		
Code	Centre to Centre	Width
4060	76mm	127mm

**2 Mackintosh Design Pull Handle – Hill House 1903**

Finish: ANT		
Code	Centre to Centre	Width
4061	76mm	114mm

**3 Mackintosh Design Escutcheon**

Finish: ANT		
Code	Height	Width
4277	70mm	32mm

**4 Mackintosh Design Bell Push**

Finish: ANT		
Code	Height	Width
4278	100mm	50mm

**5 Mackintosh Design Door Knocker**

Finish: ANT		
Code	Height	Width
4279	157mm	70mm

**6 Block and Bar Handles.**

2 block version 254mm illustrated  
 Finishes: ANT, POL, PCP, PNP, SCP, SNP  
 Code: ARBAR2  
 Diameter: 13mm  
 Bar length: 51mm 102mm 152mm 204mm 254mm  
 CTC fixing: n/a 73.5mm 123.5mm 175.5mm 225.5mm

**7 Code: ARBAR3**

1 block version 51mm illustrated  
 Diameter: 9mm  
 Bar length: 25mm 38mm 51mm 64mm 76mm 89mm  
 CTC fixing: n/a n/a n/a 40mm 52mm 65mm

**8 Wardrobe Drawer Pull Handle**

Supplied with wooden central bar  
 Finishes: ANT, POL, PNP, SNP  
 Code Height Width  
 2833 229mm 35mm

**9 Vertical Wardrobe Pull Handle**

Supplied with wooden central bar  
 Finishes: ANT, POL, PNP, SNP  
 Code Height Width  
 2832 178mm 35mm



1 4060



2 4061



3 4277



4 4278



5 4279



8 2833



9 2832



7 ARBAR3

6 ARBAR2

# KNOBS

Modern simple design knobs suitable for kitchens and bathrooms in chrome and nickel plated finishes sit comfortably alongside classic reproduction antique knobs from the Sheraton and Chippendale periods.

The majority of these knobs utilize an M4 rear-fixing 30mm or 40mm length machine screw, but the smaller knobs can have the traditional woodscrew face-fixings, and we still offer the original bolt & nut fixings to special order.



1 0893



2 0897



3 12064



4 1743



5 1875



6 1919



7 2039

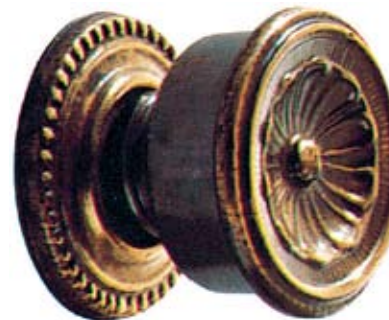

8 2368

## 1 Brass Decorative Furniture Knob and Backplate

Finish: ANT  
Code Diameter  
0893 51mm  
Fixings: R/f

## 2 Brass, Lion Face, Drawer Knob and Backplate (Empire Style)

W/s or R/f fixing.  
Finish: ANT  
Code Diameter  
0897 19mm\*  
25mm  
32mm

Fixings: W/s, R/f (\*W/s only)

## 3 Brass Decorative Cupboard Knob and Backplate

Finish: ANT  
Code Diameter  
12064 32mm  
Fixings: W/s, R/f

## 4 Brass Cabinet Knob and Backplate (Sheraton basket weave Design)

Finish: ANT  
Code Diameter  
1743 13mm\*  
16mm\*  
19mm\*  
25mm  
32mm  
38mm  
51mm\*\*

Fixings: W/s, R/f (\* W/s only) (\*\* R/f only)

## 5 Brass Shutter Knob and Backplate (Sunflower pattern)

Finishes: ANT, POL  
Code Diameter  
1875 22mm  
Fixings: W/s only

## 6 Brass Decorative Drawer Knob and Backplate

Finish: ANT  
Code Diameter  
1919 13mm\*  
16mm\*  
19mm\*  
25mm  
32mm  
38mm

Fixings: W/s, R/f (\* W/s only)

## 7 Brass Decorative Drawer Knob and Backplate

Finish: ANT  
Code Diameter  
2039 25mm  
32mm  
38mm  
Fixings: W/s, R/f

## 8 Brass Decorative Drawer Knob and Backplate

Finish: ANT  
Code Diameter  
2368 22mm  
32mm  
Fixings: W/s, R/f

**1 Brass Decorative Furniture Knob and Backplate**

Finishes: ANT, OEB  
 Code Diameter  
 3531 25mm  
 32mm  
 Fixings: W/s, R/f



1 3531

**2 Brass Decorative Furniture Knob and Backplate**

Finishes: ANT, OEB  
 Code Diameter  
 3532 32mm  
 38mm  
 51mm\*  
 Fixings: W/s, R/f (\* R/f only)



2 3532



3 3099

**3 Brass Decorative Kitchen Knob and Backplate**

Finishes: ANT, POL  
 Code Diameter  
 3099 25mm  
 32mm  
 38mm  
 51mm\*  
 Fixings: W/s, R/f (\* R/f only)



4 3533

**4 Brass Decorative Shutter Knob and Backplate**

Finishes: ANT, OEB  
 Code Diameter  
 3533 25mm  
 32mm  
 Fixings: W/s, R/f



5 4008

**5 Brass Sunflower Pattern (rear-fix) Cupboard Knob**

Finish: ANT ( see suitable backplates on page 50)  
 Code Diameter  
 4008 22mm



6 4009

**6 Brass (rear-fix) Cupboard Knob**

Finish: ANT (see suitable backplates on page 50)  
 Code Diameter  
 4009 25mm



7 5299

**7 Brass (rear-fix) Furniture Knob**

Finish: ANT  
 Code Diameter  
 5299 25mm  
 30mm  
 35mm  
 40mm



8 5300

**8 Brass (rear-fix) Furniture Knob**

Finish: ANT  
 Code Diameter  
 5300 25mm  
 30mm  
 35mm  
 40mm



9 5306

**9 Brass (rear-fix) Furniture Knob**

Finish: ANT  
 Code Diameter  
 5306 25mm  
 30mm  
 35mm  
 40mm



1 2124



2 2105



3 4063



4 4055



5 3004



6 4007



7 4023

**1 Solid Brass, Flat Head, Furniture Sash Knob**

Finishes: ANT, POL  
Code Diameter  
2124 9.5mm  
13mm  
16mm  
19mm  
25mm\*  
32mm\*

Fixings: W/s (\* R/f also available)

**2 Solid Brass, Dome Head, Furniture Sash Knob**

Finishes: ANT, POL  
Code Diameter  
2105 9.5mm  
13mm  
16mm  
19mm  
25mm\*  
32mm\*

Fixings: W/s (\* R/f also available)

**3 Solid Brass, Mushroom style, Kitchen Knob (rear fix)**

Finishes: ANT, POL, PCP, PNP, SCP, SNP  
Code Diameter  
4063 13mm  
16mm  
19mm  
25mm  
32mm  
38mm

**4 Solid Brass, Kitchen Cupboard Knob**

Finishes: ANT, POL, PNP, SNP  
Code Diameter  
4055 9.5mm\*  
13mm\*  
16mm\*  
19mm\*\*  
25mm\*\*  
32mm\*\*

Fixings: R/f, W/s (\* W/s only) (\*\* R/f only)

**5 Solid Brass, Kitchen Cupboard Knob and Backplate**

Finishes: ANT, POL, PCP, PNP, SCP, SNP  
Code Diameter  
3004 19mm  
25mm  
32mm  
38mm\*

Fixings: R/f, W/s, (\* R/f only)

**6 Solid Brass, Plain Cupboard Knob (rear fix)**

Finish: ANT (see suitable backplates on page 50)  
Code Diameter  
4007 25mm

**7 Sand Cast Brass, Oval Cupboard Knob (rear fix)**

Finish: ANT (see suitable backplates on page 49 and 50)  
Code Width  
4023 32mm

**1 Solid Brass, Contemporary style Furniture Knob (rear fix)**

Finishes: SAT, SNP  
 Code Diameter  
 3101 25mm  
 32mm  
 38mm



1 3101

**2 Solid Brass, Contemporary style Furniture Knob (rear fix)**

Finishes: SAT, SNP  
 Code Diameter  
 3102 32mm



2 3102

**3 Solid Brass, Contemporary style Furniture Knob (rear fix)**

Finishes: SAT, SNP  
 Code Diameter  
 3103 25mm  
 32mm  
 38mm



3 3103

**4 Solid Brass, Contemporary style Furniture Knob (rear fix)**

Finishes: SAT, SNP  
 Code Diameter  
 3104 32mm  
 38mm



4 3104

**5 Solid Brass, Plain Face, Kitchen Knob (rear fix)**

Finishes: SAT/SNP, SNP/SAT  
 Code Height Diameter  
 4200P 33mm 25mm



5 4200P

**6 Solid Brass, Moon Face, Kitchen Knob (rear fix)**

Finish: SAT/SNP, SNP/SAT  
 Code Height Diameter  
 4200M 33mm 25mm



6 4200M

**7 Solid Brass, Sun Face, Kitchen Knob (rear fix)**

Finishes: SAT/SNP, SNP/SAT  
 Code Height Diameter  
 4200S 33mm 25mm



7 4200S

**8 Solid Brass, Plain Face, Kitchen Knob (rear fix)**

Finish: SAT/SNP, SNP/SAT  
 Code Height Diameter  
 4202P 25mm 25mm



8 4202P

**9 Solid Brass, Moon Face, Kitchen Knob (rear fix)**

Finishes: SAT/SNP, SNP/SAT  
 Code Height Diameter  
 4202M 25mm 25mm



9 4202M

**10 Solid Brass, Sun Face, Kitchen Knob (rear fix)**

Finishes: SAT/SNP, SNP/SAT  
 Code Height Diameter  
 4202S 25mm 25mm



10 4202S



1 6923



2 6924



3 6925



4 6927



5 6928A



6 6929C



7 FK



8 4006



9 KBR1195

## 1 Plain Victorian style China Knob

Standard stock white. Other colours to order.

Code	Diameter
6923	32mm
	38mm
	51mm
	57mm

## 2 Plain Victorian style China Knob (gold effect backplate)

Code	Diameter
6924	35mm
	51mm

## 3 Plain Victorian style China Knob

Code	Diameter
6925	32mm
	38mm
	51mm

## 4 Cream or White cracked effect Porcelain Knob

Code	Diameter
6927	32mm
	38mm
	57mm

## 5 Cream coloured Porcelain Knob

Code	Diameter
6928A	35mm

## 6 Crystal effect Knob

Code	Diameter
6929C	35mm

## 7 Plain beech unfinished Wooden Knob with Screw

Code	Diameter
FK	16mm
	25mm
	35mm
	48mm
	54mm

## 8 Sand Cast Brass dummy Key Pull (rear fix)

Finish: ANT (see suitable backplates on page 50)

Code	Width
4006	25mm

## 9 Malleable Iron Oval Knob (rear fix)

Code	Width
KBR1195	35MM

**1 Solid Brass Cupboard Knob (rear fix)**

Finishes: ANT, POL, PCP, PNP, SCP, SNP

Code	Diameter
2324	19mm
	25mm
	32mm

**2 Solid Brass Oval Cupboard Knob (rear fix)**

Finish: ANT, POL, PCP, PNP, SCP, SNP

Code	Diameter
2325	19mm
	25mm
	32mm
	38mm

**3 Solid Brass Decorative Finial**

Finishes: ANT, POL

Code	Height
2360	38mm
	44mm
	51mm
	57mm
	64mm

**4 Solid Brass Decorative Finial**

Finishes: ANT, POL

Code	Height
2902	35mm

**5 Solid Brass Decorative Finial**

Finishes: ANT, POL

Code	Height
1948	35mm

**6 Solid Brass, Decorative Cupboard Knob (rear fix)**

Finishes: ANT, POL, PNP, SNP

Code	Diameter
3100	19mm
	25mm
	32mm
	38mm

**7 Solid Brass, Reeded Cupboard Knob (rear fix M5)**

Finishes: ANT, POL, PCP, PNP, SCP, SNP

Code	Diameter
3105	19mm
	25mm
	32mm
	38mm

**8 Solid Brass Oval knob on Backplate (rear fix)**

(backplate can be fixed square or diagonally)

Finishes ANT, POL, PCP, PNP, SCP, SNP (Shown in POL and SNP)

Code	Knob size	Backplate
3169	32mm	38mm sq
	38mm	38mm sq



3 2360



1 2324



2 2325



4 2902



5 1948



6 3100



7 3105



8 3169



# PULL HANDLES

This section of the catalogue ranges from the ornate Victorian drawer pull handles through the Art Deco and Art Nouveau periods and into the 1950's with many of the Dresser Pulls.

Many are face fixing pulls and finish coordinating woodscrews are included, whilst some have the more simplistic rear-fixing method. All can be bought in nickels and chromes to suit modern kitchen styles or in the traditional antique or polished brass for solid wooden furniture and cabinets.



1 2942



2 3049



3 3050



4 269



5 279



6 3090



7 3091



8 3097



9 4045



10 4046



11 4047



12 4093

## 1 Forged Brass shell design Drawer Pull Handle

Finishes: ANT, POL, PCP, PNP, SCP, SNP

Code	Height	Width
2942	51mm	102mm

## 2 Sand Cast Brass Decorative Drawer Pull, Edwardian style

Finishes: ANT, POL

Code	Height	Width
3049	38mm	98mm

## 3 Sand Cast Brass Decorative Drawer Pull, Edwardian style

Finishes: ANT, POL

Code	Height	Width
3050	32mm 38mm	76mm 108mm

## 4 Stamped Brass Drawer Pull, Victorian style

Finishes: ANT, POL, PNP, SNP

Code	Height	Width
269	41mm	95mm

## 5 Stamped Brass Drawer Pull, Art Deco Sunburst pattern

Finishes: ANT, POL, PNP, SNP

Code	Height	Width
279	38mm	95mm

## 6 Forged Brass Drawer Pull (rear fix)

Finishes: ANT, POL, PCP, PNP, SCP, SNP

Code	Height	Width	Centre to Centre
3090	40mm	90mm	76mm

## 7 Forged Brass Drawer Pull, Shell pattern (rear fix)

Finishes: ANT, POL, PCP, PNP, SCP, SNP

Code	Height	Width	Centre to Centre
3091	40mm	90mm	76mm

## 8 Forged Brass Drawer Pull

Finishes: ANT, POL, PCP, PNP, SCP, SNP

Code	Height	Width
3097	45mm	98mm

## 9 Sand Cast Brass, Drawer Pull Handle, Plain Arts & Crafts design

Finishes: ANT, POL

Code	Height	Width
4045	25mm	76mm

## 10 Sand Cast Brass, Drawer Pull, Floral Arts & Crafts design

Finishes: ANT, POL

Code	Height	Width
4046	25mm	76mm

## 11 Stamped Brass Drawer Pull, Art Nouveau design

Finishes: ANT, POL, PNP, SNP

Code	Height	Width
4047	51mm	89mm

## 12 Forged Brass Drawer Pull, Art Deco design (rear fix)

Finishes: ANT, POL, PNP, SNP

Code	Height	Width
4093	48mm	102mm



**1 Sand Cast Brass Drawer Pull, Art Deco design**

Finishes: ANT, POL

Code	Height	Width
4272	32mm	80mm
	45mm	111mm



1 4272

**2 Forged Brass Drawer Pull Handle**

Finishes: ANT, POL, PCP, PNP, SCP, SNP

Code	Height	Width
888	28mm	97mm



2 888



3 6933

**3 Stamped Brass Drawer Pull**

Finishes: ANT, POL, PCP, PNP, SCP, SNP

Code	Height	Width
6933	40mm	95mm

**4 Sand Cast Brass, Cardframe style Drawer Pull**

Finishes: ANT, POL

Code	Height	Width
2187	75mm	102mm



4 2187



5 2541



6 2174

**5 Forged Brass, Cardframe style Drawer Pull**

Finishes: ANT, POL, PCP, PNP, SCP, SNP

Code	Height	Width
2541	73mm	95mm

**6 Forged Brass Drawer Pull**

Finishes: ANT, POL, PCP, PNP, SCP, SNP

Code	Height	Width
2174	40mm	95mm

**7 Sand Cast Brass Pedestal style Pull Handle**

Finish: ANT

Code	Height
4043	83mm
	95mm
	108mm



7 4043

**8 Sand Cast Brass Knob Pull Handle**

(knob is solid brass)

Finish: ANT

Code	Height
4042	83mm
	95mm
	108mm



8 4042

**9 Sand Cast Brass Suffolk style Fixed Latch Pull Handle**

(does not operate latch)

Finishes: ANT, POL

Code	Height
4041	127mm



9 4041



10 4040

**10 Gravity Cast Brass, Large Pull Handle, Arts & Crafts design**

Finishes: ANT, POL, PCP, PNP, SCP, SNP

Code	Height
4040	163mm

# PULL HANDLES



1 KBR565



2 4029



3 4030



4 4031



5 4032



6 4034



7 4035



8 4036

## 1 Iron Decorative Pull Handle

Finish Black

Code	Height
KBR565	102MM
	178MM

## 2 Sand Cast Brass Dresser Pull Handle (rear fix)

Finishes: ANT, POL, PCP, PNP, SCP, SNP

Code	Width
4029	76mm

## 3 Sand Cast Brass Dresser Pull Handle (rear fix)

Finishes: ANT, POL, PCP, PNP, SCP, SNP

Code	Width	Centre to Centre
4030	102mm	76mm

## Sand Cast brass Dresser Pull Handle

4 Finishes: ANT, POL, PCP, PNP, SCP, SNP

Code	Width
4031	102mm
	127mm

## Sand Cast Brass Dresser Pull Handle (rear fix)

5 Finishes: ANT, POL, PCP, PNP, SCP, SNP

Code	Width
4032	76mm

## 6 Sand Cast Brass Dresser Pull Handle

Finishes: ANT, POL, PCP, PNP, SCP, SNP

Code	Width
4034	127mm

## 7 Sand Cast Brass Dresser Pull Handle

Finishes: ANT, POL, PCP, PNP, SCP, SNP

Code	Width
4035	108mm

## 8 Sand Cast Brass Dresser Pull Handle (rear fix)

Finishes: ANT, POL, PCP, PNP, SCP, SNP

Code	Width	Centre to Centre
4036	108mm	89mm

**1 Sand Cast Brass Dresser Pull Handle (rear fix)**

Finishes: ANT, POL, PNP, SNP

Code Width  
2838 88mm

**2 Sand Cast Brass Sash Window Pull Handle**

Finishes: ANT, POL, PCP, PNP, SCP, SNP

Code Width  
2024 102mm  
127mm  
153mm

**3 Sand Cast Brass, cranked Chicago Pull Handle**

Finishes: ANT, POL

Code Width  
4088 146mm  
165mm

**4 Sand Cast Brass Dresser Pull Handle**

Finishes: ANT, POL, PCP, PNP, SCP, SNP

Code Width  
4037 114mm

**5 Sand Cast Brass Dresser Pull Handle (rear fix)**

Finishes: ANT, POL, PCP, PNP, SCP, SNP

Code Width  
4038 83mm  
102mm

**6 Sand Cast Brass Dresser Pull Handle**

Finishes: ANT, POL

Code Width  
4039 102mm

**7 Lost-Wax Brass Cast Pull Handle, Ribbon & Bow Pattern (offset)**

Finish: ANT, POL

Code Width  
4080 127mm

**8 Sand Cast Brass Pull Handle, Ribbon & Bow Pattern**

Finish: ANT, POL

Code Width  
4080 165mm



1 2838



2 2024



3 4088



4 4037



5 4038



6 4039



7 4080



8 4080

# PULL HANDLES



1 8257



2 KBR3960



3 2773



4 4092



5 5252



6 5253



7 5251

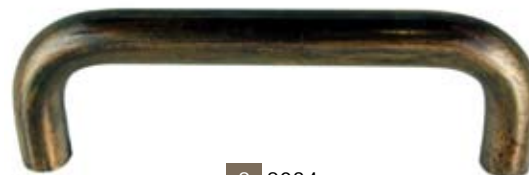

8 8034

**1 Sand Cast Brass, Decorative Pull Handle (rear fix)**

Code	Height
8257	89mm
	140mm

**2 Iron Drawer Pull**

Finish Black

Code	Height	Width
KBR3960	41mm	108mm

**3 Sand Cast Brass, Sash Window Pull Handle, Art Nouveau style**

Finishes: ANT, POL, PNP, SNP

Code	Width
2773	121mm

**4 Sand Cast Brass drawer Pull, Art Nouveau style**

Finishes: ANT, POL, PNP, SNP

Code	Width
4092	98mm

**5 Modern Pull Handle**

Finish: POL, SNP

Code	Centre to Centre
5252	96mm

**6 Modern Pull Handle**

Finish: POL, SNP

Code	Centre to Centre
5253	96mm

**7 Modern Pull Handle**

Finish: POL, SNP

Code	Centre to Centre
5251	96mm

**8 Solid brass one-piece Utility style Cabinet Pull Handle**

Finishes: ANT, POL, PCP, SCP

Code	Centre to Centre
8034	102mm
	152mm

## ARCHITECTURAL PULL AND APPLIANCE HANDLES

A range of solid cast and turned brass handles combining timeless beauty with rear fixed strength.

Traditionally used for the more discerning domestic and commercial building refurbishments and new build but also increasingly specified as appliance pulls for the Kitchen manufacturing markets, particularly in the U.S.A.

### 1 Pull Handle, Art Deco Style rear bolt fix

Code	Length	Projection
9512	190mm	40mm
9522	230mm	49mm
(9512 and 9522 same pattern)		

### 2 Pull Handle, Classic Victorian Style rear bolt fix

Code	Length	Projection
1976	218mm	62mm
	250mm	62mm

### 3 Pull Handle, Beaded Georgian Design rear bolt fix

Code	Length	Projection
3934	250mm	58mm

### 4 Pull Handle, Cranked Victorian Style rear bolt fix

Code	Length	Projection
6999	215mm	62mm
	245mm	62mm

### 5 Forged Brass Traditional Pull Handle (also available rear fix )

Code	Overall Length
H1435	254mm



This is a new range of European handles, pulls, and knobs designed with the modern kitchen in mind. The sleek lines and minimalist look give this range a high-tech, contemporary feel. Made from pressure die-cast brass and mazak they are finished to an excellent quality, making this an exciting addition to the Martin range of kitchen fittings.

Finishes are the standard chrome and nickel, both polished and satin as well as a special shot-blast aluminium look, we call 'DULL'. Fitted to the right furniture however, these handles and knobs are anything but dull!



1 TM152



2 TM154

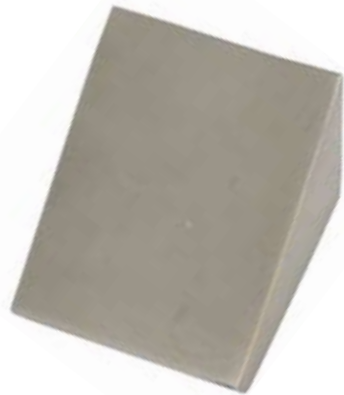

3 TM130



4 TP228



5 TM148



6 TM131

### 1 Tubular Pull Handle – 25mm Brass Tube with Mazak Posts

Finishes: Dull, PCP, SCP, PNP, SNP

Code	Depth	Centre to Centre	Length
TM152	38mm	96mm	106mm
	38mm	128mm	138mm
	38mm	224mm	234mm
	38mm	352mm	362mm

Other sizes available by special order minimum quantity 200

### 2 Square Section Pull Handle – 16mm Brass Section with Mazak Posts

Finishes: Dull, PCP, SCP, PNP, SNP

Code	Depth	Centre to Centre	Length
TM154	41mm	96mm	110mm
	41mm	128mm	142mm
	41mm	224mm	238mm
	41mm	352mm	366mm

Other sizes available by special order minimum quantity 200

### 3 Angled (one-piece) Kitchen Pull

Finishes: Dull, PCP, SCP, PNP, SNP

Code	Depth	Centre to Centre	Length	Projection
TM130	45mm	32mm	45mm	25.15mm

### 4 Cube Shaped Kitchen Knob - Mazak

Finishes: Dull, PCP, SCP, PNP, SNP

Code	Height	Width	Depth
TP228	20mm	20mm	25mm

### 5 Square design Kitchen Pull - Mazak

Finishes: Dull, PCP, SCP, PNP, SNP

Code	Height	Width	Depth
TM148	55mm	55mm	20mm

### 6 Angled (one-piece) Drawer Pull

Finishes: Dull, PCP, SCP, PNP, SNP

Code	Depth	Centre to Centre	Length	Projection
TM131	45mm	160mm	180mm	25.15mm
	45mm	224mm	244mm	25.15mm
	45mm	480mm	500mm	25.15mm

Other sizes available by special order minimum quantity 200

**1 Square Handle**

Finishes: ANT, POL (Illustrated in Satin Brass)

Code Centre to Centre  
 6805 76mm  
 102mm  
 152mm  
 203mm

**2 Square Drop Handle**

Finishes: ANT, POL

Code Length of drop  
 6825 60mm

**3 Square Twist Drop Handle**

Finishes: ANT, POL

Code Length of drop  
 6865 60mm

**4 Diamond Drop Handle**

Finishes: ANT, POL

Code Length of drop  
 6826 60mm

**5 Diamond Twist Drop Handle**

Finishes: ANT, POL

Code Length of drop  
 6866 60mm

**6 Square Twist Handle**

Finishes: ANT, POL

Code Centre to Centre  
 6845 76mm  
 102mm  
 152mm  
 203mm  
 204mm

**7 Diamond Handle**

Finishes: ANT, POL

Code Centre to Centre  
 6806 76mm  
 102mm  
 152mm  
 203mm

**8 Diamond Twist Handle**

Finishes: ANT, POL

Code Centre to Centre  
 6846 76mm  
 102mm  
 152mm  
 203mm

This began life as the Gothic range and was later afforded the title Hockley after another district of Birmingham synonymous with the Jewellery trade.

Whilst we wouldn't be so bold to claim this as a gem of our own making, it is a very interesting and unusual range of fittings.

Intriguingly the handles are fitted directly into the rosettes, rather than have several parts that can be fiddly and time consuming. The rosettes are fixed from the rear and once finished in either satin brass (shown on 6805) or very dark antique (particularly gothic looking) really make a statement on a kitchen or living room. This entire range is made as sand cast brass.



1 6805



2 6825



3 6865



6 6845



4 6826



5 6866



7 6806



8 6846

# SWAROVSKI® ELEMENTS

A range of sparkling handles as unique as they are striking.

Combining Italian design flair with genuine CRYSTALLIZED™ SWAROVSKI ELEMENTS, this collection of knobs and pull handles add an extra dimension to the Martin range of interior fittings. Fitted onto high gloss laminate drawer fronts and cupboards these handles will create a hugely bright and impressive reflection on all who are captured by their light.

There are 5 different shapes to these knobs and handles. Each is available with either a square or a triangular inlaid crystal detail.

A comprehensive availability of finishes is offered: Special Old Colour, Iron Look, Polished Chrome, Polished Nickel, Matt Nickel, Black Nickel, Gold Plated, Antique Silver.

	Code	Width	Length	Projection
1	1348A	15mm	146mm	25mm.....32mm c/c
2	1348B	15mm	99mm	25mm.....32mm c/c
3	2343	40mm	51mm	24.5mm
4	2344	27mm	38.5mm	24.5mm
5	2345	15mm	27.5mm	21.5mm



1 1348A



2 1348B



3 2343



4 2344



5 2345



Code	Width	Length	Projection
1 1349A	15mm	146mm	25mm...32mm c/c
2 1349B	15mm	99mm	25mm ..32mm c/c
3 2346	40mm	51mm	24.5mm
4 2347	27mm	38.5mm	24.5mm
5 2348	15mm	27.5mm	21.5mm



3 2346



4 2347



1 1349A

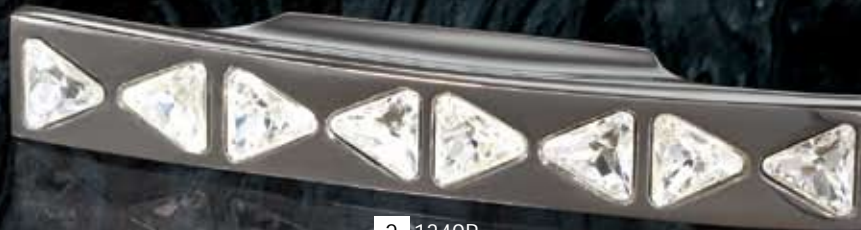

2 1349B



5 2348

These are some terrific designs that we have brought together as Art Deco. Fabulous zig-zag designs, Aztec themes, bold geometric patterns, all classic elements of original Art Deco style. However we believe that many more products in the catalogue have Deco influences.

Look at the Aston Cross and Warstone, some of the Edwardian handles and the Hexagon Suite.



**1 Solid Brass, fluted Wardrobe Pull Handle**

Finishes: ANT, POL, PNP, SNP  
Code Height Width  
2831 178mm 12mm

**2 Sand Cast Brass Plate Handle (rear fix)**

Finishes: ANT, POL, PNP, SNP  
Code Height Width Centre to centre  
2775 45mm 130mm 100mm

**3 Solid Brass, fluted Round Pull Handle**

Finishes: ANT, POL, PNP, SNP  
Code Height Width  
2830 67mm 67mm

**4 Forged Brass, chevron Drawer Pull**

Finishes: ANT, POL, PNP, SNP  
Code Width  
2834 89mm  
134mm

**5 Forged Brass, fluted Drawer Pull**

Finishes: ANT, POL, PNP, SNP  
Code Width  
2837 92mm  
140mm

**6 Sand Cast Brass, Victorian style Plate Handle**

Finishes: ANT, POL  
Code Height Width  
2867 28mm 89mm

**7 Stamped Brass Plate Handle (sand cast grip)**

Finishes: ANT, POL, PNP, SNP  
Code Height Width  
3053 54mm 95mm

**8 Sand Cast Brass Azteco Plate Handle**

Finishes: ANT, POL  
Code Height Width  
4067 36mm 127mm

**9 Sand Cast Brass Plate Handle**

Finish: ANT, POL  
Code Height Width  
4071 32mm 98mm

**10 Sand Cast Brass, Azteco Cabinet Handle**

Art Deco style  
Finishes: ANT, POL  
Code Centre to Centre  
4267 102mm

**11 Forged Brass Dresser Pull Handle**

Finishes: ANT, POL, PNP, SNP  
Code Width  
9502 95mm

**12 Solid Brass Cupboard Knob**

Finishes: ANT, POL, PNP, SNP  
Code Height Width Length  
9595 19mm 18mm 32mm  
19mm 22mm 38mm

**1 Stamped Brass, Edwardian Plate Handle**

Finish: SOC

Code	Height	Width
3027	48mm	89mm

**2 Stamped Brass, Victorian Plate Handle**

Finish: SOC

Code	Height	Width
3038	64mm	114mm

**3 Sand Cast Brass, Arts & Crafts Plate Handle**

Finishes: ANT, POL

Code	Height	Width
4466	85mm	76mm

**4 Sand Cast Brass, Arts & Crafts Pedestal Plate Handle**

Finishes: ANT, POL

Code	Height	Width
4465	125mm	35mm

**5 Sand Cast Brass, Arts & Crafts Plate Handle**

Finishes: ANT, POL

Code	Height	Width
4284	72mm	130mm

**6 Sand Cast Brass, Arts & Crafts Pedestal Plate Handle**

Finishes: ANT, POL

Code	Height	Width
4288	132mm	42mm

**7 Sand Cast Brass, Arts & Crafts Plate Handle**

Finishes: ANT, POL

Code	Height	Width
4364	45mm	94mm
	55mm	110mm

**8 Sand Cast Brass, Arts & Crafts Pedestal Plate Handle**

Finishes: ANT, POL

Code	Height	Width
4365	102mm	36mm
	114mm	40mm

All of these are sand-cast and hand-made in solid brass except products 13-15, which are made as heavy stamped plates.

They epitomize the fluid natural styling of Art Nouveau and when fitted to the plainest sideboard or chest of drawers can transform the furniture into a feature piece for the home.

Like Art Deco, Art Nouveau is still not a mainstream style for furniture production but to achieve that element of individuality and to certainly catch the eye these handles are ideal.



1 3027



2 3038



3 4466



4 4465



5 4284



6 4288



7 4364



8 4365

# ASTON CROSS

This range was designed in-house and has already been used by quality furniture manufacturers on dining and living room ranges that clearly have an Art Deco or Arts & Crafts feel to them.

Each design is available in 3 sizes to make the range one of the most comprehensive in our catalogue, and therefore suitable for all sizes of furniture production.

Incidentally the name is taken from the area of Birmingham where the original Armac factory was located back in the 1930's, and the 'Aston Cross' is portrayed by the slotted design element on the backplates. All backplates are stamped brass, and the rings and pulls are brass formed.



1 4142



2 4122



3 4124



4 4162



5 4144



6 4164

**1 Plate Handle**  
 Finishes: SAT, SNP

Code	Height	Width
4142	23mm	95mm
	28mm	110mm
	32mm	130mm

**2 Plate Handle**  
 Finishes: SAT, SNP

Code	Height	Width
4122	23mm	95mm
	28mm	110mm
	32mm	130mm

**3 Cabinet Handle**  
 Finishes: SAT, SNP

Code	Centre to Centre
4124	64mm
	76mm
	89mm

**4 Plate Handle**  
 Finishes: SAT, SNP

Code	Height	Width
4162	23mm	95mm
	28mm	110mm
	32mm	130mm

**5 Cabinet Handle**  
 Finishes: SAT, SNP

Code	Centre to Centre
4144	64mm
	76mm
	89mm

**6 Cabinet Handle**  
 Finishes: SAT, SNP

Code	Centre to Centre
4164	64mm
	76mm
	89mm

**1 Pedestal Handle, available with or without keyhole**

Finishes: SAT, SNP

Code	Height	Width
4120	95mm	34mm
	110mm	40mm
	130mm	48mm

**2 Pedestal Handle, available with or without keyhole**

Finishes: SAT, SNP

Code	Height	Width
4140	95mm	34mm
	110mm	40mm
	130mm	48mm

**3 Pedestal Handle, available with or without keyhole**

Finishes: SAT, SNP

Code	Height	Width
4160	95mm	34mm
	110mm	40mm
	130mm	48mm

**4 Ring Handle**

Finishes: SAT, SNP

Code	Width
4146	28mm
	34mm
	40mm

**5 Ring Handle**

Finishes: SAT, SNP

Code	Width
4166	28mm
	34mm
	40mm

**6 Solid Brass Furniture Knob**

Finishes: SAT, SNP

Code	Diameter
4143	32mm

**7 Ring Handle**

Finishes: SAT, SNP

Code	Width
4126	28mm
	34mm
	40mm

**8 Square Escutcheon**

Finishes: SAT, SNP

Code	Height	Width
4118	26mm	26mm

**9 Vertical Diamond Escutcheon**

Finishes: SAT, SNP

Code	Height	Width
4158V	46mm	28mm

**10 Horizontal Diamond Escutcheon**

Finishes: SAT, SNP

Code	Height	Width
4158H	28mm	46mm

**11 Round Escutcheon**

Finishes: SAT, SNP

Code	Height	Width
4138	28mm	28mm



1 4120



2 4140



3 4160



4 4146



5 4166



6 4143



7 4126



8 4118



9 4158V



10 4158H



11 4138

# WARSTONE

This is the companion range to the Aston Cross and is named after another traditional area of Birmingham still within a stones throw of our current home in Duddeston.

The range is in effect the same design as the Aston Cross only without the four cross slots on the backplates. This gives it a more solid look and whilst it is still Art Deco in its styling it does have a more contemporary feel, particularly when used in the Satin Nickel finish. The other standard finish being Satin Brass as illustrated.

All backplates are stamped brass, and the rings and pulls are brass formed.



1 4152



2 4112



3 4114



4 4132



5 4154



6 4134

## 1 Plate Handle

Finishes: SAT, SNP

Code	Height	Width
4152	23mm	95mm
	28mm	110mm
	32mm	130mm

## 2 Plate Handle

Finishes: SAT, SNP

Code	Height	Width
4112	23mm	95mm
	28mm	110mm
	32mm	130mm

## 3 Cabinet Handle

Finishes: SAT, SNP

Code	Centre to Centre
4114	64mm
	76mm
	89mm

## 4 Plate Handle

Finishes: SAT, SNP

Code	Height	Width
4132	23mm	95mm
	28mm	110mm
	32mm	130mm

## 5 Cabinet Handle

Finishes: SAT, SNP

Code	Centre to Centre
4154	64mm
	76mm
	89mm

## 6 Cabinet Handle

Finishes: SAT, SNP

Code	Centre to Centre
4134	64mm
	76mm
	89mm

**1 Pedestal Handle, available with or without keyhole**

Finishes: SAT, SNP

Code	Height	Width
4130	95mm	34mm
	110mm	40mm
	130mm	48mm

**2 Pedestal Handle, available with or without keyhole**

Finishes: SAT, SNP

Code	Height	Width
4110	95mm	34mm
	110mm	40mm
	130mm	48mm

**3 Pedestal Handle, available with or without keyhole**

Finishes: SAT, SNP

Code	Height	Width
4150	95mm	34mm
	110mm	40mm
	130mm	48mm

**4 Ring Handle**

Finishes: SAT, SNP

Code	Width
4136	28mm
	34mm
	40mm

**5 Ring Handle**

Finishes: SAT, SNP

Code	Width
4156	28mm
	34mm
	40mm

**6 Solid Brass Furniture Knob**

Finishes: SAT, SNP

Code	Diameter
4133	32mm

**7 Ring Handle**

Finishes: SAT, SNP

Code	Width
4116	28mm
	34mm
	40mm

**8 Square Escutcheon**

Finishes: SAT, SNP

Code	Height	Width
4118	26mm	26mm

**9 Vertical Diamond Escutcheon**

Finishes: SAT, SNP

Code	Height	Width
4158V	46mm	28mm

**10 Horizontal Diamond Escutcheon**

Finishes: SAT, SNP

Code	Height	Width
4158H	28mm	46mm

**11 Round Escutcheon**

Finishes: SAT, SNP

Code	Height	Width
4138	28mm	28mm



1 4130



2 4110



3 4150



4 4136



5 4156



6 4133



7 4116



8 4118



9 4158V



10 4158H



11 4138

# MISSION

The Mission range is designed with Shaker style furniture in mind. Shaker is a hugely popular style for kitchens and has been since probably the mid 1990's.

The ethos of Shaker furniture is very similar to that of the Arts & crafts movement. Hand-made product that was functional but of a good quality so that it would last.

The hammered effect version in this range is very symbolic of the way handles and rings would have been made and looks stunning in the Antique or satin finishes.

The plain (un-hammered) version is very striking in either polished brass or polished chrome and nickel and looks fabulous on darker woods.



1 4075

2 4275



3 4186



4 4286



5 4074



6 4274



7 4076



8 4276



9 4073



10 4273

**1 Stamped Brass Ring Handle**

Finish: ANT  
Code 4075      Width 51mm

**2 Stamped Brass Ring Handle**

Finishes: ANT, POL  
Code 4275      Width 51mm

**3 Sand Cast Brass Cabinet Hinge**

Finish: ANT  
Code 4186      Height 76mm      Width 38mm

**4 Sand Cast Brass Cabinet Hinge**

Finishes: ANT, POL  
Code 4286      Height 76mm      Width 38mm

**5 Stamped Brass Escutcheon**

Finish: ANT  
Code 4074      Width 32mm

**6 Stamped Brass Escutcheon**

Finishes: ANT, POL  
Code 4274      Width 32mm

**7 Stamped Brass Pedestal Handle, available with or without keyhole**

Finish: ANT  
Code 4076      Height 96mm      Width 45mm

**8 Stamped Brass Pedestal Handle, available with or without keyhole**

Finishes: ANT, POL  
Code 4276      Height 96mm      Width 45mm

**9 Stamped Brass Plate Handle**

Finish: ANT  
Code 4073      Height 57mm      Width 108mm

**10 Stamped Brass Plate Handle**

Finishes: ANT, POL  
Code 4273      Height 57mm      Width 108mm



**1 Hexagon Ring Handle (sand cast brass ring)**

Solid brass hexagonal ring pull handle.

Finish: ANT

Code	Height	Width
2918	45mm	25mm

**2 Hexagon Drop Handle**

Solid brass hexagonal drop handle pull

Finish: ANT

Code	Height	Width	Drop Length
2919	54mm	25mm	38mm

**3 Hexagon Pedestal Handle**

Solid brass hexagonal pedestal pull handle.

With or without keyhole

Finish: ANT

Code	Height	Width
2921	89mm	22mm

**4 Hexagon Plate Handle**

Finish: ANT

Code	Width
2917	89mm

**5 Hexagon Cabinet Handle (forged brass grip)**

Finish: ANT

Code	Centre to Centre
2920	64mm
	83mm
	92mm
	102mm

**6 Hexagon Pull Handle**

Finish: ANT

Code	Width	Centre to Centre
2922	89mm	51mm
	102mm	64mm

This range was developed from the 2920 cabinet handle, which is a traditional reproduction antique fitting dating back to the early 19th Century. We were intrigued by the geometric design of the backplate and the flat surfaces of the grip and we sought to expand on that using modern hexagon brass bar turned into drops and pulls.

The result is this excellent and very unique range of handles that has its origin firmly rooted in the past but with the application of design and the use of modern finishes such as Satin Nickel creates a very strikingly modern contemporary suite of furniture or kitchen fittings.



1 2918



2 2919



4 2917



5 2920



3 2921



6 2922

# CABINET HANDLES

These handles are really at the heart of Armac's core business.

We are manufacturers of traditional reproduction antique brass cabinet fittings, and these, probably more than any other range in the catalogue, perfectly illustrate that fact.

Manufactured in a variety of methods from sand-castings to forgings and turned parts they are finished to look old and grace any antique cabinet or reproduction piece. Still supplied in the traditional way with separate grips, pommels, threads and nuts and available as standard in the Armac antique finish.

Note: All sizes in this range are ctc - centre to centre



1 1680



2 1682



3 1684



4 1685



5 1686



6 1687



7 1688



8 1689

## 1 Forged brass Handle with stamped rosettes

Finishes: ANT, POL

Code	Centre to Centre
1680	60mm
	76mm
	89mm

## 2 Forged brass Handle with stamped rosettes

Finishes: ANT, POL

Code	Centre to Centre
1682	76mm
	89mm
	102mm

## 3 Forged brass Handle with stamped rosettes

Finishes: ANT, POL

Code	Centre to Centre
1684	64mm
	76mm

## 4 Forged brass Handle with stamped rosettes

Finishes: ANT, POL

Code	Centre to Centre
1685	51mm
	57mm
	64mm
	70mm
	76mm
	83mm
	89mm
	95mm
	102mm

## 5 Forged brass Handle with stamped rosettes

Finishes: ANT, POL

Code	Centre to Centre
1686	51mm
	57mm
	64mm
	70mm
	76mm
	83mm
	89mm
	95mm
	102mm

## 6 Forged brass Handle with stamped rosettes

Finishes: ANT, POL

Code	Centre to Centre
1687	64mm
	83mm
	89mm

## 7 Sand cast brass Cabinet Handle and rosettes

Finishes: ANT, POL

Code	Centre to Centre
1688	64mm
	89mm

## 8 Sand cast brass Handle with stamped rosettes

Finishes: ANT, POL

Code	Centre to Centre
1689	64mm
	83mm
	92mm

**1 Forged brass Handle with stamped rosettes**

Finishes: ANT, POL  
 Code Centre to Centre  
 1691 83mm  
 89mm



1 1691

**2 Sand cast brass Handle with stamped rosettes**

Finishes: ANT, POL  
 Code Centre to Centre  
 1692 83mm



2 1692

**3 Sand cast brass Handle with stamped rosettes**

Finishes: ANT, POL  
 Code Centre to Centre  
 1693 64mm  
 76mm



3 1693

**4 Sand cast brass Handle with stamped rosettes**

Finishes: ANT, POL  
 Code Centre to Centre  
 1695 83mm



4 1695

**5 Sand cast brass Cabinet Handle and rosettes**

Finishes: ANT, POL  
 Code Centre to Centre  
 1734 86mm



5 1734

**6 Forged brass Handle with stamped rosettes**

Finishes: ANT, POL  
 Code Centre to Centre  
 1806 64mm  
 76mm  
 89mm  
 102mm



6 1806

**7 Forged brass Handle with stamped rosettes**

Finishes: ANT, POL  
 Code Centre to Centre  
 1837 64mm  
 76mm  
 89mm  
 102mm



7 1837

**8 Sand cast brass Cabinet Handle and rosettes**

Finishes: ANT, POL  
 Code Centre to Centre  
 2000 64mm  
 76mm  
 89mm



8 2000



1 2770



2 8207



3 3082



4 3083



5 3501



6 3502



7 4089



8 4079

- 1 Sand cast brass Cabinet Handle and rosettes**  
 Finishes: ANT, POL  
 Code Centre to Centre  
 2770 76mm
- 2 Decorative forged brass Cabinet Handle**  
 Finishes: ANT, POL  
 Code Centre to Centre  
 8207 57mm  
 76mm
- 3 Sand cast brass Cabinet Handle and rosettes**  
 Finish: ANT  
 Code Centre to Centre  
 3082 64mm  
 89mm  
 108mm
- 4 Sand cast brass Handle with stamped rosettes**  
 Finish: ANT  
 Code Centre to Centre  
 3083 64mm  
 89mm  
 108mm
- 5 Forged brass Handle with stamped rosettes**  
 Finish: OEB  
 Code Centre to Centre  
 3501 64mm  
 76mm  
 89mm
- 6 Forged brass Handle with stamped rosettes**  
 Finish: OEB  
 Code Centre to Centre  
 3502 64mm  
 76mm  
 89mm
- 7 Forged brass Handle with stamped rosettes**  
 Finish: ANT  
 Code Centre to Centre  
 4089 64mm  
 76mm  
 89mm  
 114mm
- 8 Forged brass Handle with stamped rosettes**  
 Finish: ANT  
 Code Centre to Centre  
 4079 64mm  
 76mm  
 89mm  
 114mm

**1 Sand cast brass Handle with stamped rosettes**

Finish: ANT  
 Code Centre to Centre  
 9106 83mm  
 95mm

**2 Sand cast brass Cabinet Handle and rosettes**

Finishes: ANT, POL  
 Code Centre to Centre  
 8374 76mm  
 89mm

**3 Sand cast brass Handle with stamped rosettes**

Finish: ANT  
 Code Centre to Centre  
 9067 76mm

**4 Brass pressure die cast Handle with stamped rosettes**

Finishes: ANT  
 Code Centre to Centre  
 5092 89mm  
 102mm

**5 Brass pressure die cast Cabinet Handle and backplates**

Finish: ANT  
 Code Centre to Centre  
 5115 64mm  
 96mm

**6 Brass pressure die cast Cabinet Handle and backplates**

Finish: ANT  
 Code Centre to centre  
 5118 64mm  
 82mm  
 96mm

**7 Brass pressure die cast Cabinet Handle and backplates**

Finish: ANT  
 Code Centre to centre  
 5206 64mm  
 96mm



# EDWARDIAN HANDLES

This extensive range of ornate design plate handles and matching pedestal or wardrobe handles was re-introduced by Bryan McGrail, the son of the founder, back in the 1980's. At the time these were widely used to re-vamp plain Victorian chests and the increasingly popular pine chests and pine bedroom furniture.

This is still the practice today and more so these handles are finding their way to genuine Edwardian furniture via the antique restorers. Some have Art Deco elements, many have Art Nouveau influences but all are quite distinctly Edwardian. All are manufactured as stamped brass backplates with forged or sand cast grips.



1 2870



2 3026



3 3029



4 3030



5 3031



6 3040



7 3041



8 3042



9 3043



10 3044



11 3045



12 3046

## 1 Small Edwardian style Plate Handle

Finish: SOC

Code	Width	Height	Centre to Centre
2870	60mm	38mm	38mm

## 2 Decorative Edwardian style Plate Handle

Finish: SOC

Code	Width	Height	Centre to Centre
3026	92mm	38mm	51mm
	114mm	48mm	67mm

## 3 Decorative Edwardian style Plate Handle

Finish: SOC

Code	Width	Height	Centre to Centre
3029	64mm	28mm	32mm
	89mm	41mm	41mm

## 4 Decorative Edwardian style Plate Handle

Finish: SOC

Code	Width	Height	Centre to Centre
3030	102mm	51mm	76mm

## 5 Decorative Edwardian style Plate Handle

Finish: SOC

Code	Width	Height	Centre to Centre
3031	67mm	38mm	48mm
	89mm	48mm	60mm

## 6 Decorative Edwardian style Plate Handle

Finish: SOC

Code	Width	Height	Centre to Centre
3040	117mm	60mm	98mm

## 7 Decorative Edwardian style Plate Handle

Finish: SOC

Code	Width	Height	Centre to Centre
3041	127mm	60mm	95mm

## 8 Decorative Edwardian style Plate Handle

Finish: SOC

Code	Width	Height	Centre to Centre
3042	105mm	48mm	80mm

## 9 Decorative Edwardian style Plate Handle

Finish: SOC

Code	Width	Height	Centre to Centre
3043	95mm	48mm	83mm

## 10 Decorative Edwardian style Plate Handle

Finish: SOC

Code	Width	Height	Centre to Centre
3044	105mm	57mm	70mm

## 11 Decorative Edwardian style Plate Handle

Finish: SOC

Code	Width	Height	Centre to Centre
3045	114mm	51mm	76mm

## 12 Decorative Edwardian style Plate Handle

Finish: SOC

Code	Width	Height	Centre to Centre
3046	92mm	48mm	70mm

**1 Decorative Edwardian style Plate Handle**  
 Finish: SOC  
 Code Width Height Centre to Centre  
 3047 111mm 25mm 57mm



1 3047

**2 Stamped Brass, Edwardian Plate Handle**  
 Finish: SOC  
 Code Height Width  
 3028 48mm 70mm



2 3028

**3 Small Edwardian style Plate Handle**  
 Finish: SOC  
 Code Width Height Centre to Centre  
 3048 54mm 28mm 41mm



3 3048

**4 Victorian, Art Nouveau style Plate Handle**  
 Finish: SOC  
 Code Width Height Centre to Centre  
 3037 102mm 57mm 98mm



4 3037

**5 Edwardian Pedestal Handle. With or without keyhole**  
 Finish: SOC  
 Code Width Height  
 3068 28mm 89mm



5 3068

**6 Edwardian Pedestal Handle. With or without keyhole**  
 Finish: SOC  
 Code Width Height  
 3069 28mm 95mm



6 3069

**7 Edwardian Wardrobe Handle. With 5mm spindle. With or without keyhole**  
 Finish: SOC  
 Code Width Height  
 3071 28mm 89mm  
 28mm 114mm



7 3071

**8 Edwardian Pedestal Handle. With or without keyhole**  
 Finish: SOC  
 Code Width Height  
 3071 28mm 89mm  
 28mm 114mm



8 3071

**9 Edwardian Pedestal Handle. With or without keyhole**  
 Finish: SOC  
 Code Width Height  
 3070 25mm 86mm



9 3070

**10 Edwardian Pedestal Handle. Available with or without keyhole**  
 Finish: OEB  
 Code Width Height  
 3561 27mm 102mm



10 3561

**11 Edwardian Pedestal Handle. Available with or without keyhole**  
 Finish: OEB  
 Code Width Height  
 3562 27mm 89mm



11 3562

**12 Edwardian Pedestal Handle. Available with or without keyhole**  
 Finish: OEB  
 Code Width Height  
 3564 25mm 95mm



12 3564

# OVAL PLATE HANDLES

Another classic Armac stock-in-trade range of furniture handles. It is important to note that these handles were always made as cold brass stampings. That was how they came into being and the tools and patterns we use today are the original patterns acquired from Pearson, Page and Jewsbury when we bought their business back in the early 1960's. In truth this is but a small fraction of the many patterns we have available to us.

These are the most popular designs and as well as providing that Hepplewhite look for an old desk or drawer table, they also work as an excellent 'cover-all' replacement handle. The size and shape of the plate enables the restorer to cover up a multitude of old drill holes and past plate markings very successfully. All are manufactured as stamped brass backplates with forged brass grips.



2 1629



3 1630



4 1631



5 1632



6 1633



7 1634



8 1635



9 1638



10 1641



1 1628

## 1 Stamped brass Oval Plate Handle

Finish: ANT

Code	Width	Height	Centre to Centre
1628	76mm	57mm	60mm

## 2 Stamped brass Oval Plate Handle

Finish: ANT

Code	Width	Height	Centre to Centre
1629	86mm	57mm	70mm

## 3 Stamped brass Oval Plate Handle

Finish: ANT

Code	Width	Height	Centre to Centre
1630	89mm	51mm	76mm

## 4 Stamped brass Oval Plate Handle

Finish: ANT

Code	Width	Height	Centre to Centre
1631	86mm	60mm	67mm

## 5 Stamped brass Oval Plate Handle

Finish: ANT

Code	Width	Height	Centre to Centre
1632	64mm	38mm	54mm
	89mm	48mm	80mm
	114mm	60mm	105mm

## 6 Stamped brass Oval Plate Handle

Finish: ANT

Code	Width	Height	Centre to Centre
1633	51mm	41mm	38mm
	64mm	51mm	48mm
	76mm	60mm	60mm
	89mm	60mm	70mm
	95mm	67mm	80mm

## 7 Stamped brass Oval Plate Handle

Finish: ANT

Code	Width	Height	Centre to Centre
1634	64mm	38mm	54mm
	83mm	45mm	67mm
	95mm	54mm	83mm
	114mm	67mm	89mm

## 8 Stamped brass Oval Plate Handle

Finish: ANT

Code	Width	Height	Centre to Centre
1635	64mm	35mm	54mm
	89mm	51mm	80mm
	108mm	54mm	92mm

## 9 Stamped brass Oval Plate Handle

Finish: ANT

Code	Width	Height	Centre to Centre
1638	76mm	60mm	60mm

## 10 Stamped brass Oval Plate Handle

Finish: ANT

Code	Width	Height	Centre to Centre
1641	86mm	60mm	73mm



**1 Stamped brass Oval Plate Handle**

Finish: ANT

Code	Width	Height	Centre to Centre
1642	89mm	70mm	67mm



1 1642

**2 Stamped brass Oval Plate Handle**

Finish: ANT

Code	Width	Height	Centre to Centre
1643	86mm	70mm	70mm



2 1643

**3 Stamped brass Oval Plate Handle**

Finish: ANT

Code	Width	Height	Centre to Centre
1644	89mm	70mm	73mm



3 1644

**4 Stamped brass Oval Plate Handle**

Finish: ANT

Code	Width	Height	Centre to Centre
1645	92mm	48mm	80mm



4 1645

**5 Stamped brass Oval Plate Handle**

Finish: ANT

Code	Width	Height	Centre to Centre
1646	89mm	48mm	80mm
	108mm	57mm	89mm



5 1646

**6 Stamped brass Oval Plate Handle**

Finish: ANT

Code	Width	Height	Centre to Centre
1647	89mm	51mm	80mm



6 1647

**7 Stamped brass Oval Plate Handle**

Finish: ANT

Code	Width	Height	Centre to Centre
1650	89mm	51mm	80mm



7 1650

**8 Stamped brass Oval Plate Handle**

Finish: ANT

Code	Width	Height	Centre to Centre
1649	76mm	60mm	64mm



8 1649

**9 Stamped brass Oval Plate Handle**

Finish: ANT

Code	Width	Height	Centre to Centre
1654	86mm	70mm	67mm



9 1654

**10 Stamped brass Oval Plate Handle**

Finish: ANT

Code	Width	Height	Centre to Centre
1655	95mm	57mm	80mm



10 1655

**11 Stamped brass Oval Plate Handle**

Finish: ANT

Code	Width	Height	Centre to Centre
1657	86mm	57mm	73mm



11 1657

**12 Stamped brass Oval Plate Handle**

Finish: ANT

Code	Width	Height	Centre to Centre
1662	64mm	48mm	48mm
	76mm	57mm	60mm
	89mm	64mm	73mm



12 1662

# OVAL PLATE HANDLES



1 1664



2 1670



3 1787



4 1788



5 2943



6 3544



7 3542



8 3543



9 3541



10 9533



11 4072



12 9103

## 1 Stamped brass Oval Plate Handle

Finish: ANT

Code	Width	Height	Centre to Centre
1664	86mm	51mm	73mm

## 2 Stamped brass Oval Plate Handle

Finish: ANT

Code	Width	Height	Centre to Centre
1670	114mm	64mm	105mm

## 3 Stamped brass Oval Plate Handle

Finish: ANT

Code	Width	Height	Centre to Centre
1787	57mm	48mm	45mm
	76mm	57mm	64mm
	89mm	70mm	67mm

## 4 Stamped brass Oval Plate Handle

Finish: ANT

Code	Width	Height	Centre to Centre
1788	76mm	60mm	64mm

## 5 Stamped brass Oval Plate Handle

Finish: ANT

Code	Width	Height	Centre to Centre
2943	64mm	35mm	51mm
	89mm	48mm	67mm
	108mm	67mm	76mm

## 6 Stamped brass Oval Plate Handle

Finishes: ANT, OEB

Code	Width	Height	Centre to Centre
3544	64mm	51mm	54mm
	76mm	60mm	60mm

## 7 Stamped brass Oval Plate Handle

Finishes: ANT, OEB

Code	Width	Height	Centre to Centre
3542	70mm	39mm	57mm
	83mm	48mm	70mm
	89mm	53mm	73mm

## 8 Stamped brass Oval Plate Handle

Finishes: ANT, OEB

Code	Width	Height	Centre to Centre
3543	102mm	60mm	89mm

## 9 Stamped brass Oval Plate Handle

Finishes: ANT, OEB

Code	Width	Height	Centre to Centre
3541	64mm	49mm	53mm
	76mm	60mm	60mm

## 10 Stamped brass Oval Plate Handle

Finish: ANT

Code	Width	Height	Centre to Centre
9533	83mm	54mm	70mm

## 11 Sand cast brass Oval Plate Handle

Finish: ANT

Code	Width	Height	Centre to Centre
4072	80mm	54mm	64mm

## 12 Stamped brass Oval Plate Handle

Finish: ANT

Code	Width	Height	Centre to Centre
9103	89mm	73mm	64mm

**1 Solid brass Wardrobe Pull. Available with or without keyhole**

Finish: ANT		
Code	Height	Width
1695	95mm	32mm

**2 Solid brass Pedestal Pull. Available with or without keyhole**

Finish: ANT		
Code	Height	Width
1695	89mm	32mm

**3 Solid brass Pedestal Pull. Available with or without keyhole**

Finish: ANT		
Code	Height	Width
1963	67mm	25mm

**4 Solid brass Pedestal Pull. Available with or without keyhole**

Finish: ANT		
Code	Height	Width
3098	83mm	25mm

**5 Solid brass Pedestal Pull. Available with or without keyhole**

Finish: ANT		
Code	Height	Width
1701	92mm	28mm

**6 Solid brass Wardrobe Pull. Available with or without keyhole**

Finish: ANT		
Code	Height	Width
1701	121mm	38mm

**7 Solid brass Pedestal style Ring Pull Handle**

Finish: ANT		
Code	Height	Width
1767	89mm	38mm

**8 Solid brass Pedestal style Ring Pull Handle**

Finish: ANT		
Code	Height	Width
1867	104mm	51mm

Most of these vertical fitted handles are made as companion products to the plate handles in the previous section of the catalogue, or the cabinet handles from pg 31. Hence we use many of the same numbers such as 1512, 1509, 1701 1685.

The smaller pedestal handles are surface mounted with the use of brass pins or small woodscrews. The larger wardrobe handles are made to operate cabinet locks and latches so have a 5mm square spindle on the back that will pass through the lock (see page 103 pattern No. 878). Many can also be specially ordered with a cupboard turn to secure a cupboard door without the need of a lock or latch.



1 1695



2 1695



3 1963



4 3098



5 1701



6 1701



7 1767



8 1867

# PEDESTAL & WARDROBE HANDLES



1 4048



2 1503



3 1509



4 1509



5 1685



6 1686



7 1686



8 1512

**1 Solid brass Pedestal style fretted Plate with Drop**

Finish: ANT		
Code	Height	Width
4048	152mm	28mm

**2 Solid brass Pedestal Pull. Available with or without keyhole**

Finish: ANT		
Code	Height	Width
1503	83mm	22mm

**3 Solid brass Wardrobe Pull. Available with or without keyhole**

Finish: ANT		
Code	Height	Width
1509	102mm	28mm

**4 Solid brass Pedestal Pull. Available with or without keyhole**

Finish: ANT		
Code	Height	Width
1509	83mm	22mm

**5 Solid brass Pedestal Pull. Available with or without keyhole**

Finish: ANT		
Code	Height	Width
1685	83mm	25mm

**6 Solid brass Wardrobe Pull. Available with or without keyhole**

Finish: ANT		
Code	Height	Width
1686	98mm	35mm

**7 Solid brass Pedestal Pull. Available with or without keyhole**

Finish: ANT		
Code	Height	Width
1686	67mm	28mm

**8 Solid brass Pedestal Pull. Available with or without keyhole**

Finish: ANT		
Code	Height	Width
1512	83mm	28mm

**1 Solid brass Wardrobe Pull. Available with or without keyhole**

Finish: ANT  
Code Height Width  
1512 95mm 32mm

**2 Solid brass Pedestal Pull. Available with or without keyhole**

Finish: ANT  
Code Height Width  
1680 76mm 19mm

**3 Solid brass Wardrobe Pull. Available with or without keyhole**

Finish: ANT  
Code Height Width  
1680 111mm 38mm

**4 Solid brass Pedestal Pull. Available with or without keyhole**

Finish: ANT  
Code Height Width  
1762 83mm 28mm

**5 Cast brass pedestal pull. No keyhole**

Finish: ANT  
Code Height Width  
1702 68mm 28mm

**6 Cast brass pedestal pull. No keyhole**

Finish: ANT  
Code Height Width  
1703 80mm 28mm

**7 Stamped brass Pedestal Pull**

Finish: ANT  
Code Height Width  
5172 82mm 25mm

**8 Stamped brass Pedestal Pull. With keyhole**

Finish: ANT  
Code Height Width  
5173 82mm 25mm



1 1512



2 1680



3 1680



4 1762



5 1702



6 1703



7 5172



8 5173

# PLATE HANDLES

Here we have a fabulous range of plain, fretted and engraved plate handles. All widely used in the antique reproduction furniture industry as well as the furniture restoration trade. These pages are full of classic designs with the periods covered being mainly the 17th and 18th centuries.

We have Chinese influence Chippendale designs, classic Sheraton fittings, and neo-classical styles from Robert Adams and William Kent.

Still supplied in the traditional way with separate grips, pommels, threads and nuts and available as standard in the Armac antique finish.



1 1503



2 1504



3 1505



4 1506



5 1507



6 1509



7 1518



8 1514



9 1515

## 1 Sand cast brass Plate Handle

Finish: ANT

Code	Width	Height	Centre to Centre
1503	70mm	45mm	51mm
	76mm	41mm	51mm
	92mm	57mm	73mm
	110mm	78mm	75mm

## 2 Sand cast brass Plate Handle

Finish: ANT

Code	Width	Height	Centre to Centre
1504	83mm	51mm	57mm

## 3 Sand cast brass Plate Handle

Finish: ANT

Code	Width	Height	Centre to Centre
1505	80mm	51mm	51mm
	92mm	51mm	54mm

## 4 Sand cast brass Plate Handle

Finish: ANT

Code	Width	Height	Centre to Centre
1506	64mm	34mm	45mm
	89mm	35mm	45mm
	108mm	60mm	76mm

## 5 Sand cast brass Plate Handle

Finish: ANT

Code	Width	Height	Centre to Centre
1507	86mm	57mm	57mm

## 6 Stamped brass Plate and forged grip

Available in 16g, 18g, or 20g material

Finish: ANT

Code	Width	Height	Centre to Centre
1509	64mm	41mm	48mm
	76mm	45mm	54mm
	89mm	51mm	64mm
	102mm	54mm	67mm
	114mm	64mm	76mm

## 7 Stamped brass Plate and forged grip

Finish: ANT

Code	Width	Height	Centre to Centre
1518	64mm	51mm	48mm
	76mm	60mm	57mm
	89mm	67mm	67mm
	108mm	67mm	76mm

## 8 Sand cast brass Plate Handle

Finish: ANT

Code	Width	Height	Centre to Centre
1514	89mm	67mm	70mm
	108mm	76mm	76mm

## 9 Stamped brass Plate and forged grip

Finish: ANT

Code	Width	Height	Centre to Centre
1515	76mm	41mm	54mm
	83mm	41mm	64mm
	92mm	57mm	70mm

**1 Sand cast brass Plate Handle**

Finish: ANT

Code	Width	Height	Centre to Centre
1516	64mm	32mm	51mm
	79mm	48mm	64mm
	89mm	48mm	64mm



1 1516

**2 Sand cast brass Plate Handle**

Finish: ANT

Code	Width	Height	Centre to Centre
1517	76mm	45mm	54mm
	102mm	51mm	76mm



2 1517

**3 Sand cast brass Plate Handle**

Finish: ANT

Code	Width	Height	Centre to Centre
1511	89mm	64mm	57mm
	102mm	70mm	64mm



3 1511

**4 Sand cast brass Plate Handle**

Finish: ANT

Code	Width	Height	Centre to Centre
1520	89mm	76mm	64mm
	111mm	83mm	80mm



4 1520

**5 Sand cast brass Plate Handle**

Finish: ANT

Code	Width	Height	Centre to Centre
1522	83mm	67mm	60mm



5 1522

**6 Stamped brass Plate and forged grip**

Finish: ANT

Code	Width	Height	Centre to Centre
1524	114mm	57mm	92mm



6 1524

**7 Sand cast brass Plate Handle**

Finish: ANT

Code	Width	Height	Centre to Centre
1526	86mm	60mm	64mm



7 1526

**8 Stamped brass Plate and forged grip**

Finish: ANT

Code	Width	Height	Centre to Centre
1529	76mm	64mm	57mm
	92mm	76mm	70mm



8 1529

**9 Sand cast brass Plate Handle**

Finish: ANT

Code	Width	Height	Centre to Centre
1528	89mm	57mm	67mm
	102mm	64mm	73mm



9 1528



1 1530



2 1534



3 1535



4 1536



5 1539



6 1512



7 1543



8 1545



9 1546

**1 Sand cast brass Plate Handle**

Finish: ANT

Code	Width	Height	Centre to Centre
1530	95mm	80mm	73mm

**2 Stamped brass Plate and forged grip**

Finish: ANT

Code	Width	Height	Centre to Centre
1534	76mm	51mm	60mm
	89mm	54mm	67mm
	102mm	64mm	76mm
	114mm		

**3 Sand cast brass Plate Handle**

Finish: ANT

Code	Width	Height	Centre to Centre
1535	76mm	41mm	57mm
	89mm	48mm	67mm
	102mm	54mm	73mm

**4 Stamped brass Plate and forged grip**

Finish: ANT

Code	Width	Height	Centre to Centre
1536	76mm	51mm	60mm
	89mm	54mm	67mm
	102mm	64mm	76mm
	114mm	64mm	83mm

**5 Sand cast brass Plate Handle**

Finish: ANT

Code	Width	Height	Centre to Centre
1539	89mm	73mm	73mm

**6 Stamped brass Plate and forged grip**

Available in 16g, 18g or 20g material.

Finish: ANT

Code	Width	Height	Centre to Centre
1512	64mm	48mm	45mm
	76mm	51mm	51mm
	89mm	64mm	57mm
	102mm	72mm	76mm

**7 Stamped brass Plate and forged grip**

Finish: ANT

Code	Width	Height	Centre to Centre
1543	102mm	83mm	76mm

**8 Sand cast brass Plate Handle**

Finish: ANT

Code	Width	Height	Centre to Centre
1545	89mm	60mm	64mm
	108mm	70mm	67mm

**9 Sand cast brass plate handle**

Finish: ANT

Code	Width	Height	Centre to Centre
1546	64mm	50mm	50mm
	76mm	64mm	70mm
	89mm	64mm	70mm
	102mm	70mm	73mm



**1 Sand cast brass Plate Handle**

Finish: ANT

Code	Width	Height	Centre to Centre
1548	76mm	51mm	57mm
	89mm	64mm	64mm
	102mm	70mm	76mm

**2 Stamped brass Plate and forged grip**

Finish: ANT

Code	Width	Height	Centre to Centre
1550	76mm	60mm	60mm
	92mm	67mm	70mm
	111mm	76mm	83mm

**3 Sand cast brass Plate Handle**

Finish: ANT

Code	Width	Height	Centre to Centre
1551	76mm	48mm	60mm

**4 Sand cast brass Plate Handle**

Finish: ANT

Code	Width	Height	Centre to Centre
1556	111mm	76mm	67mm

**5 Sand cast brass Plate Handle**

Finish: ANT

Code	Width	Height	Centre to Centre
2940	89mm	64mm	64mm
	102mm	76mm	70mm
	114mm	80mm	78mm

**6 Stamped brass Plate and forged grip**

Finish: ANT

Code	Width	Height	Centre to Centre
2941	76mm	42mm	54mm
	83mm	41mm	64mm
	92mm	57mm	70mm

**7 Stamped brass Plate and forged grip**

Available in 16g, 18g or 20g material.  
Finish: ANT

Code	Width	Height	Centre to Centre
1792	51mm	38mm	38mm
	64mm	51mm	51mm
	76mm	57mm	57mm
	89mm	67mm	70mm

**8 Stamped brass Plate and forged grip**

Finish: ANT

Code	Width	Height	Centre to Centre
1823	108mm	86mm	80mm

**9 Stamped brass Plate and forged grip**

Finish: ANT

Code	Width	Height	Centre to Centre
1832	89mm	65mm	68mm



1 1548



2 1550



3 1551



4 1556



5 2940



6 2941



7 1792



8 1823



9 1832



1 1833



2 1866



3 1868



4 1885



5 1886



6 1926



7 1927



8 1928



9 1936

**1 Sand cast brass Plate Handle**

Finish: ANT

Code	Width	Height	Centre to Centre
1833	70mm	45mm	35mm

**2 Sand cast brass Plate Handle**

Finish: ANT

Code	Width	Height	Centre to Centre
1866	89mm	64mm	64mm

**3 Stamped brass Plate and forged grip**

Finish: ANT

Code	Width	Height	Centre to Centre
1868	76mm	57mm	60mm
	92mm	67mm	70mm
	111mm	76mm	83mm

**4 Stamped brass Plate and forged grip**

Finish: ANT

Code	Width	Height	Centre to Centre
1885	95mm	51mm	67mm

**5 Sand cast brass Plate Handle**

Finish: ANT

Code	Width	Height	Centre to Centre
1886	102mm	73mm	70mm

**6 Sand cast brass Plate Handle**

Finish: ANT

Code	Width	Height	Centre to Centre
1926	83mm	54mm	67mm

**7 Stamped brass Plate and forged grip**

Finish: ANT

Code	Width	Height	Centre to Centre
1927	73mm	64mm	57mm

**8 Sand cast brass Plate Handle**

Finish: ANT

Code	Width	Height	Centre to Centre
1928	83mm	45mm	60mm
	89mm	51mm	64mm
	102mm	54mm	70mm

**9 Sand cast brass Plate Handle**

Finish: ANT

Code	Width	Height	Centre to Centre
1936	98mm	67mm	73mm

**1 Stamped brass Plate and forged grip**

Finish: ANT			
Code	Width	Height	Centre to Centre
1944	89mm	54mm	67mm



1 1944

**2 Sand cast brass Plate Handle**

Finish: ANT			
Code	Width	Height	Centre to Centre
1540	92mm	51mm	60mm
	102mm	51mm	64mm
	114mm	57mm	73mm



2 1540

**3 Stamped brass Plate and forged grip**

Finishes: ANT, OEB			
Code	Width	Height	Centre to Centre
3587	64mm	42mm	50mm
	92mm	45mm	68mm



3 3587

**4 Sand cast brass Plate Handle**

Finish: ANT			
Code	Width	Height	Centre to Centre
1956	102mm	83mm	76mm



4 1956

**5 Stamped brass Plate and forged grip**

Finish: ANT			
Code	Width	Height	Centre to Centre
1960	76mm	48mm	57mm



5 1960

**6 Stamped brass Plate and forged grip**

Finish: ANT			
Code	Width	Height	Centre to Centre
1975	114mm	80mm	76mm
	140mm	95mm	102mm



6 1975

**7 Sand cast brass Plate Handle**

Finish: ANT			
Code	Width	Height	Centre to Centre
1982	102mm	73mm	83mm



7 1982

**8 Sand cast brass Plate Handle**

Finish: ANT			
Code	Width	Height	Centre to Centre
2002	98mm	67mm	70mm



8 2002

**9 Sand cast brass Plate Handle**

Finish: ANT			
Code	Width	Height	Centre to Centre
2923	102mm	70mm	76mm
	117mm	76mm	86mm



9 2923

**10 Sand cast brass Plate Handle**

Finish: ANT			
Code	Width	Height	Centre to Centre
2924	102mm	51mm	76mm



10 2924

**11 Sand cast brass Plate Handle**

Finish: ANT			
Code	Width	Height	Centre to Centre
2925	79mm	35mm	60mm
	92mm	41mm	67mm



11 2925



1 1500



2 7920



3 1946



4 3095



5 3581



6 3583



7 3601



8 3602



9 3603



10 1640

**1 Sand cast brass Plate Handle**

Finish: ANT

Code	Width	Height	Centre to Centre
1500	89mm	48mm	60mm
	102mm	51mm	64mm
	114mm	60mm	73mm

**2 Sand cast brass Plate Handle**

Finish: ANT

Code	Width	Height	Centre to Centre
7920	76mm	45mm	51mm

**3 Sand cast brass Plate Handle**

Finish: ANT

Code	Width	Height	Centre to Centre
1946	108mm	54mm	67mm

**4 Solid cast brass Plate**

Finish: ANT

Code	Width	Height
3095	25mm	140mm

**5 Stamped brass Plate and forged grip**

Finishes: ANT, OEB

Code	Width	Height	Centre to Centre
3581	76mm	39mm	54mm
	89mm	45mm	54mm
	102mm	60mm	69mm

**6 Stamped brass Plate and forged grip**

Finishes: ANT, OEB

Code	Width	Height	Centre to Centre
3583	70mm	51mm	54mm
	86mm	67mm	73mm
	102mm	78mm	78mm

**7 Stamped brass Plate and forged grip**

Finish: OEB

Code	Width	Height	Centre to Centre
3601	76mm	51mm	57mm

**8 Stamped brass Plate and forged grip**

Finish: OEB

Code	Width	Height	Centre to Centre
3602	76mm	51mm	57mm
	89mm	57mm	76mm

**9 Stamped brass Plate and forged grip**

Finish: OEB

Code	Width	Height	Centre to Centre
3603	86mm	60mm	67mm

**10 Stamped brass Plate and forged grip**

Finish: ANT

Code	Width	Height	Centre to Centre
1640	76mm	51mm	57mm
	95mm	57mm	76mm

**1 Stamped brass Plate handle**

Finish: ANT			
Code	Width	Height	Centre to Centre
5178	96mm	48mm	64mm



1 5178

**2 Stamped brass Plate handle**

Finish: ANT			
Code	Width	Height	Centre to Centre
5164	64mm	32mm	32mm
	93mm	41mm	64mm



2 5164

**3 Solid cast brass Plate**

Finish: ANT		
Code	Height	Width
4002B	83mm	25mm



3 4002B

**4 Solid cast brass Plate**

Finish: ANT		
Code	Height	Width
4003	83mm	32mm



4 4003

**5 Decorative cast brass Plate**

Finish: ANT		
Code	Height	Width
4004	92mm	22mm



5 4004

**6 Backplate  
Decorative cast brass Plate**

Finish: ANT		
Code	Height	Width
4005	79mm	32mm



6 4005

**7 Solid cast brass Plate**

Finish: ANT		
Code	Height	Width
3094	76mm	32mm



7 3094

**8 Sand cast brass Plate Handle**

Finish: ANT			
Code	Width	Height	Centre to Centre
4044	83mm	22mm	55mm
	95mm	25mm	65mm
	108mm	25mm	65mm



8 4044

**9 Stamped brass Backplate**

Code	Width	Height
4049	28mm	98mm



9 4049

**10 Stamped brass Plate Handle**

Finish: ANT			
Code	Width	Height	Centre to Centre
4049	98mm	98mm	55mm



10 4049

**11 Large sand cast brass Plate Handle**

Finish: ANT			
Code	Width	Height	Centre to Centre
4077	127mm	64mm	92mm



11 4077

**12 Stamped brass Plate and forged grip**

Finish: ANT			
Code	Width	Height	Centre to Centre
7994	76mm	46mm	67mm
	86mm	42mm	64mm
	102mm	50mm	76mm



12 7994

# RING HANDLES

The majority of this section is from the 18th century with neo-classical designs and Georgian period pieces that are widely used on reproduction antique furniture production and restoration.

However, alongside these are many more contemporary styles that when supplied in plated finishes can look excellent on modern living furniture such as Hi-fi cabinets and kitchen drawers.

The majority of these handles use a stamped brass backplate with solid formed rings on a hook spindle with steel nut.



1 1659



2 1666



3 1667



4 1668



5 1671



6 1672



7 1770

## 1 Solid brass Ring Pull Handle

Finish: ANT	
Code	Width
1659	35mm
	51mm
	60mm

## 2 Sand cast brass Ring Pull Handle

Finish: ANT	
Code	Width
1666	38mm
	45mm
	51mm
	57mm
	67mm

## 3 Solid brass Ring Pull Handle

Finish: ANT	
Code	Width
1667	35mm
	51mm
	64mm

## 4 Solid brass Ring Pull Handle

Finish: ANT	
Code	Width
1668	38mm
	51mm
	64mm

## 5 Solid brass Ring Pull Handle

Finish: ANT	
Code	Width
1671	35mm
	51mm
	64mm

## 6 Solid brass Ring Pull Handle

Finish: ANT	
Code	Width
1672	32mm
	38mm
	51mm
	57mm

## 7 Solid brass Ring Pull Handle

Finish: ANT	
Code	Width
1770	35mm
	51mm
	64mm

**1 Sand cast brass Ring Pull Handle**

Finish: ANT	
Code	Width
1678	51mm
	64mm



1 1678

**2 Sand cast brass Ring Handle (central rear-fix screw & pin)**

Finish: ANT		
Code	Height	Width
1676	35mm	25mm
	41mm	32mm
	48mm	38mm
	48mm	44mm
	60mm	51mm
	64mm	57mm
	73mm	64mm
	76mm	70mm



2 1676

**3 Solid brass Ring Pull Handle**

Finish: ANT	
Code	Width
1750	51mm



3 1750

**4 Solid brass Ring Pull Handle**

Finish: ANT	
Code	Width
1779	38mm
	51mm
	57mm



4 1779

**5 Solid brass Ring Pull Handle**

Finish: ANT	
Code	Width
1780	38mm
	51mm



5 1780

**6 Solid brass Ring Pull Handle**

Finish: ANT	
Code	Width
1784	41mm
	64mm
	76mm



6 1784

**7 Sand cast brass Ring Pull Handle**

Finish: ANT	
Code	Width
1942	76mm



7 1942

**8 Solid brass Ring Pull Handle**

Finish: ANT	
Code	Width
1954	44mm



8 1954



1 2037



2 2759



3 3076



4 3078



5 3079



6 3621



7 3622



8 3623

**1 Sand cast brass Ring Pull Handle**

Finish: ANT  
Code 2037 Width 67mm

**2 Forged brass Ring Handle (central rear-fix screw & pin)**

Finishes: ANT, POL  
Code 2759 Width 38mm 48mm

**3 Forged brass Ring Handle (central rear-fix screw & pin)**

Finishes: ANT, POL  
Code 3076 Width 38mm

**4 Forged brass Ring Handle (central rear-fix screw & pin)**

Finishes: ANT, POL  
Code 3078 Width 38mm

**5 Forged brass Ring Handle (central rear-fix screw & pin)**

Finishes: ANT, POL  
Code 3079 Width 41mm

**6 Solid brass Ring Pull Handle**

Finish: OEB  
Code 3621 Width 38mm 51mm

**7 Solid brass Ring Pull Handle**

Finish: OEB  
Code 3622 Width 38mm 51mm

**8 Solid brass Ring Pull Handle**

Finish: OEB  
Code 3623 Width 38mm 51mm



**1 Solid brass Ring Pull Handle**

Finishes: ANT, OEB

Code	Height	Width
3624	32mm	38mm
		44mm
		51mm

**2 Solid brass Ring Pull Handle**

Finishes: ANT, OEB

Code	Width
3625	35mm
	48mm

**3 Solid brass Ring Pull Handle**

Finishes: ANT, POL

Code	Width
4350	25mm
	38mm
	51mm
	64mm

**4 Solid brass Ring Pull Handle**

Finish: ANT

Code	Width
4400	38mm
	51mm

**5 Solid brass Ring Pull Handle**

Finish: ANT

Code	Width
5130	38mm
	51mm

**6 Solid brass Ring Pull Handle**

Finish: ANT

Code	Width
0631	38mm
	51mm

**7 Solid brass Ring Pull Handle**

Finish: ANT

Code	Width
9144	44mm

**8 Solid brass Ring Pull Handle**

Finish: ANT

Code	Width
5022	22mm
	34mm
	40mm
	48mm



1 3624



2 3625



3 4350



4 4400



5 5130



6 0631



7 9144



8 5022

# DROP HANDLES

Many of these designs are from the early 18th century and are typical of the type of handles used on furniture from the William & Mary period, whilst some date back to the Restoration period beginning in the 1660's.

The 1738 Dutch drop is a classic example of this, and is still greatly used on reproduction antique desks, bureaus, and escritoire writing tables. Several of the teardrops are brass stampings and are hollow or cavity backed. This is how they were originally made (as a means of reducing the metal content at a time when brass was nearly as expensive as it is today!) We have continued to use the original press tools in our manufacturing process to make these as authentic as possible. Almost all drops are attached to a brass hook spindle and secured inside the drawer or cupboard using a steel nut.



1 1706



2 1718



3 1697



4 1699



5 1701



6 1716



7 1717



8 1719



9 1722



10 1725



11 1726

## 1 Stamped brass Drop Handle (hollow back drop)

Finish: ANT

Code	Length of Drop	Backplate Width
1706	50mm 57mm	38mm 50mm

## 2 Stamped brass Drop Handle (hollow back drop)

Finish: ANT

Code	Length of Drop	Backplate Width
1718	45mm 58mm	40mm 40mm

## 3 Forged brass Drop and stamped backplate

Finish: ANT

Code	Length of Drop	Backplate Width
1697	35mm	35mm

## 4 Forged brass Drop and stamped backplate

Finish: ANT

Code	Backplate Width	Length of Drop
1699	40mm	35mm

## 5 Forged brass Drop and stamped backplate

Finishes: ANT, POL

Code	Backplate Width	Length of Drop
1701	32mm 38mm 50mm	32mm 38mm 45mm

## 6 Sand cast brass Drop Handle

Finish: ANT

Code	Length of Drop	Width
1716	48mm	25mm

## 7 Sand cast brass fishtail Drop with stamped backplate

Finish: ANT

Code	Length of Drop	Backplate Width
1717	38mm	38mm

## 8 Sand cast brass grapevine Drop Handle

Finish: ANT

Code	Length of Drop	Width
1719	48mm	20mm

## 9 Sand cast brass acorn Drop Handle

Finish: ANT

Code	Length of Drop	Width
1722	50mm	29mm

## 10 Sand cast brass Drop with stamped backplate

Finish: ANT

Code	Length of Drop
1725	22mm

## 11 Sand cast brass Drop Handle

Finish: ANT

Code	Length of Drop
1726	44mm

**1 Sand cast brass Drop Pedestal Handle**

Finish: ANT

Code	Height	Length of Drop	Backplate Width
4052	105mm	51mm	25mm

**2 Forged brass Drop and backplate**

Finishes: ANT, POL

Code	Length of Drop	Backplate Width
1731	35mm	28mm

**3 Solid brass Ring on round plate**

Finishes: ANT, POL

Code	Length of Drop	Backplate Width
1736	35mm	32mm

**4 Forged brass Drop and stamped backplate**

Finishes: ANT, POL

Code	Length of Drop	Backplate Width
1737	35mm	28mm

**5 Sand cast brass Drop Handle**

Finish: ANT

Code	Backplate	Length of Drop	Width
1762	38mm	38mm	
	41mm	51mm	
	44mm	60mm	

**6 Solid brass Handle (Dutch Drop)**

Finishes: ANT, POL

Code	Width
1738	13mm
	16mm
	19mm
	25mm*
	32mm*
	38mm*

Fixings: W/s, R/f \*

**7 Solid brass Handle (Axe Head)**

Finishes: ANT, POL

Code	Width
1739	16mm
	19mm
	25mm*
	32mm*
	38mm*

Fixings: W/s, R/f \*

**8 Solid brass Glass Screw Drop Handle (mirror movement fitting)**

Finishes: ANT, POL

Code	Width
1740	16mm
	19mm
	25mm
	32mm
	38mm

**9 Delicate brass Cupboard Turn Drop Handle**

Finishes: ANT, POL

Code	Width
1742	19mm
	25mm
	32mm
	38mm



1 4052

2 1731

3 1736

4 1737

5 1762

6 1738

7 1739

8 1740

9 1742

# DROP HANDLES



1 1892



2 1891



3 1705



4 1952



5 1729



6 1893



7 1894



8 1898



9 1924



10 1930

## 1 Stamped brass Drop Handle (hollow back)

Finish: ANT

Code	Length of Drop	Backplate Width
1892	50mm 57mm	57mm 57mm

## 2 Sand cast Drop (hollow back) with stamped backplate

Finish: ANT

Code	Length of Drop	Backplate Width
1891	50mm	28mm

## 3 Stamped brass Drop Handle (hollow back)

Finishes: ANT, POL

Code	Length of Drop	Backplate Width
1705	51mm 50mm	28mm 28mm

## 4 Forged brass Drop and stamped backplate

Finishes: ANT, POL

Code	Height	Length of Drop	Backplate Width
1952	41mm 51mm 64mm	41mm 51mm 64mm	35mm 38mm 51mm

## 5 Forged brass Drop and stamped backplate

Finishes: ANT, POL

Code	Length of Drop	Backplate Width
1729	51mm 57mm	28mm 32mm

## 6 Stamped brass Drop Handle (hollow back)

Finish: ANT

Code	Length of Drop	Backplate Width
1893	45mm 50mm 57mm	25mm 32mm 32mm

## 7 Stamped brass Drop Handle (hollow back)

Finishes: ANT, POL

Code	Length of Drop	Backplate Width
1894	32mm 38mm 45mm 50mm 57mm	22mm 22mm 25mm 28mm 32mm

## 8 Stamped brass Drop Handle (hollow back)

Finish: ANT

Code	Length of Drop	Backplate Width
1898	51mm	35mm

## 9 Forged brass Drop and stamped backplate

Finish: ANT

Code	Length of drop	Backplate Width
1924	35mm	40mm

## 10 Solid brass Ring with solid backplate

Finishes: ANT, POL

Code	Length of Drop	Backplate Width
1930	35mm	28mm

**1 Sand cast brass Heavy Drop with solid backplate**

Finish: ANT

Code	Length of drop	Backplate width
1963	38mm	22mm
	51mm	25mm
	64mm	35mm

**2 Sand cast Drop with stamped backplate**

Finish: ANT

Code	Length of Drop	Backplate Width
1972	45mm	32mm
	51mm	32mm

**3 Forged brass Drop with stamped backplate**

Finish: Ant

Code	length of drop	backplate width
6929	35mm	26mm
	48mm	32mm
	56mm	35mm

**4 Brass Ring Pull Handle (woodscrew fixing)**

Finishes: ANT, POL

Code	diameter
2963	32mm

**5 Solid brass, Georgian design. Fixings: Face-fix, (illustrated face fix), Bolt & Nut**

Finishes: ANT, POL

Code	Width
2606	32mm
	38mm
	57mm
	64mm

**6 Solid brass, Georgian design. Fixings: Face-fix, (illustrated face fix), Bolt & Nut**

Finishes: ANT, POL

Code	Width
2633	32mm
	38mm
	57mm
	64mm

**7 Solid brass Ring Pull Handle**

Finishes: ANT, POL

Code	Diameter
8184	38mm
	44mm

**8 Solid brass swag design Drop Handle**

Finish: ANT

Code	Height	Width
5522	72mm	20mm

**9 Sand cast brass Drop (square shank tapped M4)**

Finish: ANT

Code	Height	Width
4051	45mm	25mm
	57mm	35mm



1 1963



2 1972



3 6929



4 2963



5 2606



6 2633



7 8184



8 5522



9 4051

# DROP HANDLES



1 3080



2 3081



3 3521



4 4068



5 4069



6 4070



7 3098



8 3522



9 4053



10 4054



11 5179

## 1 Sand cast brass Drop Handle

Finish: ANT

Code	Length of Drop
3080	50mm
	60mm

## 2 Sand cast brass Drop with stamped backplate

Finish: ANT

Code	Length of Drop
3081	50mm
	60mm

## 3 Forged Brass Drop and stamped backplate

Finish: OEB

Code	Length of Drop
3521	38mm

## 4 Sand cast brass Drop Handle

Finish: ANT

Code	Length of Drop
4068	51mm

## 5 Sand cast brass Drop Handle

Finish: ANT

Code	Length of Drop	Backplate Width
4069	44mm	45mm

## 6 Sand cast brass Drop Handle

Finish: ANT

Code	Length of Drop
4070	51mm

## 7 Forged brass Drop with stamped backplate

Finishes: ANT, POL

Code	Length of Drop	Backplate Width
3098	41mm	25mm
	51mm	28mm
	64mm	32mm

## 8 Forged brass Drop with stamped backplate

Finish: OEB

Code	Length of Drop
3522	41mm
	50mm

## 9 Sand cast brass Drop Handle

Finish: ANT

Code	Length of Drop	Backplate Width
4053	51mm	25mm

## 10 Sand cast brass Drop with stamped backplate

Finish: ANT

Code	Length of Drop	Backplate Width
4054	51mm	28mm

## 11 Forged brass Ring Pull Handle

Finish: ANT

Code	Height	Width
5179	51mm	32mm

Many of these escutcheons are intended to work with plate handles and cabinet handles on traditional reproduction antique furniture and antique restoration pieces. Alongside the escutcheons we also show a few paterae decorations and bed-bolt covers. The majority are brass stampings made from original press tools, although some are still made as the original sand castings.

As standard these products are supplied in the Armac antique finish, but polished brass or plated finishes can be supplied to special order.

**1 Stamped brass Escutcheon**

Code	Height	Width
1563	32mm	67mm
	38mm	73mm

**2 Stamped brass Escutcheon**

Code	Height	Width
1575	45mm	57mm

**3 Stamped brass Escutcheon**

Code	Height	Width
1584	25mm	64mm

**4 Stamped brass Escutcheon**

Code	Height	Width
1596	25mm	60mm

**5 Sand cast brass Escutcheon**

Finish: ANT		
Code	Height	Width
4078	51mm	48mm

**6 Stamped brass Escutcheon**

Finish: ANT		
Code	Height	Width
1600	25mm	70mm

**7 Stamped brass Escutcheon**

Finish: ANT		
Code	Height	Width
1764	35mm	60mm

**8 Stamped brass Escutcheon**

Finish: ANT		
Code	Height	Width
1622	28mm	48mm

**9 Stamped brass Escutcheon**

Finish: ANT		
Code	Height	Width
1500E	60mm	76mm
	68mm	92mm

**10 Sand cast brass Escutcheon**

Finish: ANT		
Code	Height	Width
1558	51mm	79mm

**11 Stamped brass Escutcheon**

Finish: ANT		
Code	Height	Width
1559	38mm	54mm
	48mm	76mm
	60mm	89mm

**12 Stamped brass Escutcheon**

Finish: ANT		
Code	Height	Width
1564	51mm	76mm
	54mm	89mm
	64mm	102mm

**13 Sand cast brass Escutcheon**

Finish: ANT		
Code	Height	Width
1566	48mm	70mm

**14 Stamped brass Escutcheon**

Finish: ANT		
Code	Height	Width
1579	67mm	64mm

**15 Stamped brass Escutcheon**

Finish: ANT		
Code	Height	Width
1608	41mm	67mm
	45mm	76mm
	51mm	89mm

**16 Stamped brass Escutcheon**

Finish: ANT		
Code	Height	Width
1616	48mm	76mm

**17 Stamped brass Escutcheon**

Finish: ANT		
Code	Height	Width
1620	48mm	60mm

**18 Sand cast brass Escutcheon**

Finish: ANT		
Code	Height	Width
1827	41mm	76mm

**19 Stamped brass Escutcheon**

Finish: ANT		
Code	Height	Width
1975KH	80mm	115mm

**20 Stamped brass Escutcheon**

Finish: ANT		
Code	Height	Width
1904	64mm	73mm



1 1563



2 1575



3 1584



4 1596



5 4078



6 1600



7 1764



8 1622



9 1500E



10 1558



11 1559



12 1564



13 1566



14 1579



15 1608



16 1616



17 1620



18 1827



19 1975KH



20 1904

# ESCUTCHEONS & COVERS



1 1580    2 1603    3 1624    4 1615    5 1852    6 1908    7 1910    8 1916



9 3051    10 1818    11 1906    12 1574    13 3513    14 1572    15 1601    16 1621

<b>1 Stamped brass Escutcheon</b> Finish: ANT Code 1580    Height 60mm    Width 22mm	<b>9 Sand cast brass Escutcheon</b> Finish: ANT Code 3051    Height 166mm    Width 25mm
<b>2 Stamped brass Escutcheon</b> Code 1603    Height 80mm    Width 22mm	<b>10 Stamped brass Escutcheon</b> Finish: ANT Code 1818    Height 124mm    Width 32mm
<b>3 Stamped brass Escutcheon</b> Finish: ANT Code 1624    Height 80mm    Width 22mm	<b>11 Stamped brass Escutcheon</b> Finish: ANT Code 1906    Height 95mm    Width 25mm
<b>4 Stamped brass Escutcheon</b> Finish: ANT Code 1615    Height 67mm    Width 19mm	<b>12 Stamped brass Escutcheon</b> Code 1574    Height 108mm    Width 19mm
<b>5 Stamped brass Escutcheon</b> Finish: ANT Code 1852    Height 121mm    Width 25mm	<b>13 Stamped brass Escutcheon</b> Finish: ANT, OEB Code 3513    Height 32mm    Width 13mm
<b>6 Stamped brass Escutcheon</b> Finish: ANT Code 1908    Height 70mm    Width 19mm	<b>14 Stamped brass Escutcheon</b> Finish: ANT Code 1572    Height 79mm    Width 22mm 92mm    25mm
<b>7 Stamped brass Escutcheon</b> Finish: ANT Code 1910    Height 64mm    Width 32mm	<b>15 Stamped brass Escutcheon</b> Finish: ANT Code 1601    Height 82mm    Width 22mm
<b>8 Stamped brass Escutcheon</b> Finish: ANT Code 1916    Height 92mm    Width 28mm	<b>16 Sand cast brass Escutcheon</b> Finish: ANT Code 1621    Height 79mm    Width 25mm



- 1 Stamped brass Escutcheon**  
Code Height Width  
1626 57mm 35mm
- 2 Stamped brass Escutcheon**  
Finish: ANT  
Code Height Width  
1568 54mm 32mm
- 3 Stamped brass Escutcheon**  
Finish: ANT  
Code Height Width  
1622 28mm 48mm
- 4 Stamped brass Escutcheon**  
Code Height Width  
1597 60mm 38mm
- 5 Stamped brass Escutcheon**  
Finish: ANT  
Code Height Width  
1567 54mm 41mm
- 6 Stamped brass Escutcheon**  
Code Height Width  
1586 41mm 32mm  
45mm 41mm
- 7 Stamped brass Escutcheon**  
Finish: ANT  
Code Height Width  
1587 41mm 38mm
- 8 Stamped brass Escutcheon**  
Code Height Width  
1594 35mm 29mm  
48mm 35mm
- 9 Stamped brass Escutcheon**  
Finish: ANT  
Code Height Width  
1625 38mm 64mm
- 10 Stamped brass Escutcheon**  
Finish: ANT  
Code Height Width  
1623 51mm 92mm
- 11 Sand cast brass Escutcheon**  
Finish: ANT  
Code Height Width  
1913 51mm 41mm  
57mm 45mm

- 12 Sand cast brass Escutcheon**  
Finish: ANT  
Code Height Width  
1588 51mm 79mm
- 13 Stamped brass Escutcheon**  
Finish: ANT  
Code Height Width  
1599 45mm 32mm
- 14 Stamped brass Escutcheon**  
Finish: ANT  
Code Height Width  
1610 41mm 38mm
- 15 Sand cast brass Escutcheon**  
Finish: ANT  
Code Height Width  
1829 41mm 32mm
- 16 Stamped brass Escutcheon**  
Finish: ANT  
Code Height Width  
1915 35mm 35mm
- 17 Stamped brass Escutcheon**  
Code Height Width  
1819 38mm 38mm
- 18 Stamped brass Escutcheon**  
Finish: ANT  
Code Height Width  
1905 45mm 45mm  
54mm 45mm





**1 Stamped brass knob tops**  
(paterae)

Code	Width
1743K	25mm 32mm 38mm 51mm

**2** Finish: ANT, POL  
Code Width  
2906 45mm

**3 Sand cast brass Bed Bolt Cover**  
Code Width  
2025 45mm

**4 Forged Bed Bolt Cover**  
Code Width  
4001 45mm

**5 Stamped brass Escutcheon**  
Code Height Width  
3512V 32mm 25mm

**6 Stamped brass Escutcheon**  
Code Height Width  
3512H 25mm 32mm

**7 Stamped brass Escutcheon**  
Code Width  
3511 32mm

**8 Stamped brass Escutcheon**  
Finishes: ANT, POL  
Code Width  
1779E 38mm

**9 Stamped brass Escutcheon**  
Finish: ANT  
Code Width  
4091 32mm

**10 Stamped brass Escutcheon**  
Finishes: PCP, POL, ANT  
Code Width  
7095 29mm

**11 Brass nozzle Escutcheon**  
Finish: ANT, POL  
Code Width  
2385 22mm

**12 Stamped brass Escutcheon**  
Finishes: PCP, POL, ANT  
Code Height Width  
7129 35mm 20mm

**13 Stamped brass Escutcheon**  
Finish: PCP, POL, ANT  
Code Height Width  
2151 57mm 44mm

**14 Stamped brass Escutcheon**  
Finish: PCP, POL, ANT  
Code Height Width  
7541 29mm 19mm

**15 Stamped brass Escutcheon**  
Finishes: PCP, POL, ANT  
Code Height Width  
8252 44mm 22mm

**16 Stamped brass Escutcheon**  
Finish: PCP, POL, ANT  
Code Height Width  
3279 38mm 25mm

**17 Stamped brass Escutcheon**  
Finishes: PCP, POL, ANT  
Code Height Width  
8451 27mm 20mm

**18 Brass Fast Fix Escutcheon**  
Two hidden inserts for fast secure fix  
Finish: ANT  
Code Height Width  
5502 20mm 10mm



1 1743K



2 2906



3 2025



4 4001



5 3512V



6 3512H



7 3511



8 1779E



9 4091



10 7095



11 2385



12 7129



13 2151



14 7541



15 8252



16 3279



17 8451



18 5502

# MILITARY & MARINE FITTINGS

The Napoleonic Wars created their own style of furniture that became known as Military or Campaign furniture.

Designed to make maximum use of the storage space in the hold of a ship when transported overseas, it is block-like in shape and often constructed in separate easily moveable sections.

Where possible the handles were flush fitted and the corners and edges were protected with brass covers.



1 1752



2 1861



3 1797



4 2079



5 2121



6 2122

## 1 Forged Brass, Military Flush Handle

Finishes: ANT, POL, PCP

Code	Height	Width
1752	38mm	64mm
	45mm	76mm
	51mm	89mm
	54mm	102mm

## 2 Forged Brass, Military Flush Handle

Finishes: ANT, POL, PCP

Code	Height	Width
1861	45mm	89mm
	48mm	114mm

## 3 Sand cast brass Lifting Handle

Finishes: ANT, POL, PCP

Code	Width across shoulders
1797	64mm
	76mm
	89mm
	102mm
	114mm

## 4 Sand cast brass Lifting Handle

Finishes: ANT, POL, PCP

Code	Width across shoulders
2079	76mm
	89mm
	102mm
	114mm
	127mm

## 5 Forged Brass Flush Ring Pull

Finishes: ANT, POL, PCP, PNP, SCP, SNP

Code	Width
2121	38mm
	44mm
	51mm

## 6 Forged Brass Flush Ring Pull

Finishes: ANT, POL, PCP, PNP, SCP, SNP

Code	Height	Width
2122	38mm	32mm
	51mm	38mm
	57mm	44mm
	64mm	51mm

**1 Sand cast brass Deck Plate**

Finishes: ANT, POL, PCP, SCP  
 Code           Width  
 2172           51mm



1 2172

**2 Sand cast brass, Swivel, Deck Plate**

Finishes: ANT, POL, PCP, SCP  
 Code   Height   Width  
 2175   51mm   38mm



2 2175

**3 Stamped Military Escutcheon**

Finishes: ANT, POL  
 Code   Height   Width  
 2927   38mm   45mm



3 2927

**4 Sand cast brass Plate Lifting Handle**

Finishes: ANT, POL  
 Code           Width  
 2436           102mm  
                  114mm  
                  127mm  
                  140mm  
                  165mm



4 2436

**5 Stamped Brass Chest Corner**

Finishes: ANT, POL  
 Code   Height   Width  
 2627   16mm   51mm  
          19mm   51mm  
          19mm   64mm



5 2627

**6 Stamped Brass Chest Strap**

Finishes: ANT, POL  
 Code   Height   Width  
 2628   16mm   51mm  
          19mm   51mm  
          19mm   64mm



6 2628

# HOOKS

We show here a range of hooks that serve many purposes.

The cabin hooks are still used today in boats but serve very well as external gate hooks or for holding back garden patio doors.

The wardrobe and coat hooks can be used under the stairs or on the backs of doors or inside wardrobes. They could be chrome plated and fitted in bathrooms for robes or towels or they could be mounted splendidly on an antique hat stand in the entrance hall.



1 2088



2 1920



3 2217



4 0810



5 4010



6 0820



7 0789

## 1 Sand cast brass Cleat Hook

Finishes: POL, ANT, PCP, SCP

Code	Height
2088	50mm
	63mm
	75mm
	100mm

## 2 Solid cast brass Cabin Hook

Finishes: ANT, PCP, POL, SCP

Code	Width
1920	76mm
	102mm
	152mm
	203mm
	254mm
	305mm

## 3 Solid cast brass Cabin Hook

Finishes: ANT, PCP, POL, SCP (illustrated SCP)

Code	Width
2217	51mm
	76mm
	102mm
	152mm

## 4 Forged brass Hat & Coat Hook

Finishes: ANT, POL, PCP, PNP, SCP, SNP

Code	Height	Width
0810	127mm	
	152mm	

## 5 Solid cast brass Hat & Coat Hook

Finish: ANT

Code	Height	Width
4010	127mm	

## 6 Forged brass Hat & Coat Hook

Finishes: ANT, POL, PCP, PNP, SCP, SNP

Code	Height	Width
0820	114mm	

## 7 Solid brass Sliding Wardrobe Hook

Finishes: ANT, POL, PCP, SCP

Code	Height
0789	19mm
	25mm

**1 Solid cast brass Picture Hook**  
**Arts & Crafts style**

Finish: ANT, POL  
 Code Height  
 2178 51mm  
 64mm  
 76mm

**2 Solid brass Wardrobe Hook**

Finishes: ANT, POL  
 Code Height  
 0783 38mm  
 44mm  
 51mm  
 64mm

**3 Forged brass Wardrobe Hook**

Finishes: ANT, POL, PCP, PNP, SCP, SNP  
 Code Height  
 2109 38mm

**4 Solid brass Double Wardrobe Hook**

Finishes: ANT, POL  
 Code Height  
 0845 64mm  
 70mm

**5 Pressed brass Glass, Mirror, Picture Plate**

Finish: Bright Brass  
 Code Height  
 206 25mm  
 207 32mm  
 208 38mm  
 51mm

**6 Stamped brass Picture hanging Moulding Hook**

Finishes: ANT, POL  
 Code Height Width  
 4280 41mm 54mm



1 2178



2 0783



3 2109



4 0845



5 206



6 4280

# BRACKETS & SHELVING

Another diverse selection that covers bracketry from the small bookcase shelf supports and tonk strip to the large handrail and rope rail brackets. Most of these items are sand-cast and hand finished at our factory in Birmingham, but we also offer, here for the first time, some beautifully machined glass shelf brackets that look stunning in polished brass or chrome plated.

With the strip and studs we also provide all that you will need to fit out a bookcase, or create some light shelving in cupboards or CD cabinets.



1 2132



2 2548



3 2578



4 3144



5 1465



6 2212



7 2331C



8 2331E

## 1 Solid cast brass, shelf support, Angle Bracket

Finish: ANT, POL		
Code	Length	Width
2132	102mm	28mm
	76mm	28mm

## 2 Sand cast brass Rope Ring Rail Bracket

Finishes: ANT, POL	
Code	Height
2548	25mm
	32mm
	38mm

## 3 Sand cast brass Rope Ring Rail Bracket

Finishes: ANT, POL	
Code	Height
2578	25mm
	32mm
	38mm

## 4 Brass Machine made round Glass Shelf Bracket

Finish: POL			
Code	Diameter	Projection	Opening
3144	38mm	25mm	10mm
3444	38mm	25mm	6mm

## 5 Brass machine made half moon Glass Shelf Bracket

Finish: POL			
Code	Length	Projection	Opening
1465	60mm	25mm	10mm
1463	60mm	25mm	6mm

## 6 Solid gravity cast brass Handrail Bracket

Finish: POL	
Code	Length
2212	64mm
	76mm
	89mm

## 7 Sand cast brass open Centre Rail Bracket

Finishes: ANT, POL	
Code	Aperture
2331C	32mm
	38mm

## 8 Sand cast brass closed End Rail Bracket

Finishes: ANT, POL	
Code	Aperture
2331E	32mm
	38mm



**1 Solid brass Bookcase Shelf Stud**

Finish: DIPPED BRASS  
 Code Diameter  
 2813 6mm  
 8mm  
 9.5mm

**2 Flat Bookcase Stud**

(use with TONK flat bookcase strip)  
 Finish: Please specify same finish as strip  
 Code  
 TONK Flat Stud

**3 Raised Bookcase Stud**

(use with bookcase strip tonk3 and tonk4)  
 Code  
 TONK Raised Stud

**4 Flat, flush fix, Bookcase Strip**

(available in solid brass, electro brass on steel and bronze finish)

Code	Lengths	Width
TONKFSTRIP	6 foot	18mm

**5 Steel Raised face fix Bookcase Strip**

(available in brass and bronze plated finishes. 6 foot lengths)

Finishes: EB or FB  
 Code Width  
 TONKRSTRIP 25mm

**6 Round brass knock in Socket for Bookcase shelving**

(use with 111aa stud)

Finish: EB or FB  
 Code Diameter  
 111AB 6mm

**7 Brass banjo shaped Bookcase Stud**

(use with 111ab socket)

Finish: EB or FB  
 Code Diameter  
 111AA 18mm

**8 Push in Rubber Buffer cushion cover**

(use with bookcase studs tonk)

Finish:  
 Code Width  
 TONKR 22mm

**9 Black Rubber Buffer**

(use with 111aa stud for glass shelving and impact reduction)

Finish:  
 Code Width  
 111BB 18mm



1 2813



2 TONK Flat Stud



3 TONK Raised Stud



4 TONKFSTRIP



5 TONKRSTRIP



6 111AB



7 111AA



8 TONKR



9 111BB

# STAYS

Jointed lid stays, solid cast brass wardrobe stays with adjustable knob to hold in place or to apply some restraint to the action. Sliding stays for many more applications.

These are excellent stays, expertly made, and beautifully finished.



1 1749H

2 1749S

3 0819

4 2730

5 2719

6 2149

7 2268

## 1 Forged brass (heavy gauge) Joint Stay

Sold as pairs. Sizes are closed

Finishes: ANT, POL

Code	Length
1749H	102mm
	127mm
	152mm
	203mm

## 2 Forged brass (light gauge) Joint Stay

Sold as pairs. Sizes are closed

Finish: POL

Code	Length
1749S	76mm
	102mm

## 3 Forged brass sliding stay

Finishes: ANT, POL, PCP, SCP

Code	Length
0819	152mm
	203mm
	254mm

## 4 Solid drawn brass sliding stay

Finishes: PCP, POL

Code	Height	Width
2730	178mm	184mm
	229mm	267mm
	292mm	327mm

## 5 Solid drawn brass sliding stay

Finishes: PCP, POL

Code	Width
2719	216mm
	254mm

## 6 Forged brass wardrobe stay

Finish: POL

Code	Width
2149	152mm
	203mm
	229mm

## 7 Sand cast brass secretaire quadrant stay (sold as pairs)

Finishes: ANT, POL

Code	Length
2268	102mm
	127mm
	152mm
	203mm

**1 Gothic Casket Handle**

Heavy cast brass Gothic chest or casket handle.  
Arts & Crafts style.  
Finishes: ANT, POL  
Code      Width      Height  
2772      84mm      225mm

**2 French Colonial Chest Handle**

Solid brass decorative chest or casket handle.  
(ASP finish illustrated)  
Finishes: ANT, POL, ASP  
Code      Width      Height  
2771      90mm      152mm

**3 Art Nouveau Chest Handle**

Solid brass chest or casket handle. Art Nouveau style (rear fixed)  
Finishes: ANT, POL  
Code      Width      Height  
2774      108mm      172mm

**4 French Colonial Chest Handle**

Solid brass decorative chest or casket handle.  
Finishes: ANT, POL  
Code      Width      Height  
2776      102mm      172mm



1 2772



2 2771



3 2774



4 2776

This is a new range for the catalogue but the patterns have been ours for a great many years. They are made from solid sand-cast brass and the majority of them will bear some considerable weight.

Whilst a good number of these may end up below ground they also look splendid when used to great effect on large chests and blanket boxes.

# CARDFRAMES

Whilst this is only a small range, the 0788 is available in 3 sizes and as such will meet most requirements of a solid brass cast cardframe. The smaller pulls are beautifully made and the larger pulls are fabulous when finished and fitted.

Our standard finish for all of these is polished brass but they look equally as good in polished chrome or satin nickel.



1 1845



2 2054



3 2091



4 2187



5 2541



6 0788

## 1 Forged brass Cardframe Finger Pull

Finishes: ANT, POL, PCP, PNP, SCP, SNP

Code	Height	Width
1845	25mm	64mm

## 2 Forged brass Cardframe

Finishes: ANT, POL, PCP, PNP, SCP, SNP

Code	Height	Width
2054	48mm	95mm (card size)

## 3 Forged brass Cardframe Finger Pull

Finishes: ANT, POL, PCP, PNP, SCP, SNP

Code	Height	Width
2091	38mm	64mm

## 4 Sand cast brass Cardframe Pull

Finishes: ANT, POL

Code	Width
2187	102mm

## 5 Forged brass Cardframe Pull

Finishes: ANT, POL

Code	Height	Width
2541	75mm	95mm

## 6 Solid brass Cardframe

Finishes: ANT, POL

Code	Height	Width
0788	25mm	51mm (cast)
	38mm	64mm (cast)
	51mm	76mm (forged)

Available in Brass, Stainless Steel, Aluminium and Plastic

Brass e.g. - Meehan  
 Stainless Steel e.g. - Grech  
 Aluminium e.g. - West  
 Plasti e.g. - Davies

A wide variety of styles and shapes as depicted.

Available in standard, reverse etching and multicoloured.

Standard e.g. - Meehan, Flintoff  
 Reverse e.g. - Coryndon  
 Multicoloured e.g. - Posse

Fixing methods either holes to suit pin fixing or easy peel self adhesive backed.

Minimum order quantity is usually 250 and will be subject to Artwork charges.

Delivery is normally 4 weeks from drawing approval.

Personalise your furniture products with your own exclusively designed logo labels.

Available in brass, aluminium, stainless steel or plastic in a wide variety of styles and shapes as depicted. They can be either blind etched, etched and filled or printed in a choice of colours. Available as pin fixing or easy peel self adhesive back.

The most popular styles are illustrated here. Contact our sales who can advise on options to suit your company. Normal minimum order is 250 off (to include artwork charges) although we have produced smaller quantities. Delivery is usually no more than 4 weeks from drawing approval.



# CATCHES & TABLE FITTINGS

This is another section that has been expanded since the previous catalogue was available. Most of the original pieces in this range are speciality fittings for tables.

Flip-top table fittings such as the 0902 or the 0885, or the loose leaf, extendable table fittings 1756 or 2006. The 0907 secretaire catch dates back to the beginning of the 19th century. To these items we have added some excellent hand-made cupboard catches that have proved to be very popular with the kitchen industry.



1 1756



2 4062



3 2006



4 2076



5 2084



6 2087



7 2638



8 1850

## 1 Forged Brass Table Fork Catch

Finishes: ANT, POL

Code	Width across prongs
1756	64mm
	76mm
	89mm
	102mm

## 2 Sand Cast Brass Table Slide

Finishes: ANT, POL

Code	Height	Width
4062	9mm	60mm

## 3 Round Table Catch, Forged Brass

Finishes: ANT, POL

Code	Width
2006	51mm
	57mm
	64mm

## 4 Sand Cast Brass Hasp & Staple

Finishes: ANT, POL

Code	Width
2076	89mm

## 5 Sand Cast Brass Hasp & Staple

Finishes: ANT, POL

Code	Height	Width
2084	32mm	83mm
	38mm	114mm

## 6 Sand Cast Brass Hasp & Staple

Finishes: ANT, POL

Code	Height	Width
2087	76mm	25mm
	102mm x 25mm	

## 7 Double Banjo Catch, Forged Brass

Finishes: ANT, POL

Code	Height	Width
2638	76mm	210mm

## 8 Banjo Catch, Forged Brass

Finishes: ANT, POL

Code	Height	Width
1850	51mm	57mm
	64mm	76mm

**1 Forged Brass Casement Fastener**

Finishes: ANT, POL, PCP, PNP, SCP, SNP

Code	Height	Diameter
0818	38mm	19mm
	50mm	25mm
	56mm	32mm
	56mm	38mm

**2 Cast Brass Padlock Latch**

Finishes: ANT, POL, PCP, PNP, SCP, SNP

Code	Height	Width
2515	54mm	38mm

**3 Forged Brass Tee Fastener**

Finishes: ANT, POL, PCP, SCP

Code	Width
8140	51mm

**4 Round Button Table Catch, Forged Brass**

Finishes: ANT, POL

Code	Width
0902	35mm
	41mm

**5 Sand Cast Brass Double Table Catch**

Finish: SAN

Code	Height	Width
0885	64mm	152mm

**6 Sand Cast Brass Cupboard Catch**

Finishes: ANT, POL, PCP, PNP, SCP, SNP

Code	Height	Width
0899	38mm	54mm

**7 Forged Brass 'Dartmouth Button Catch**

Code	Height	Width
8892	35mm	38mm

**8 Forged Brass Table Sash Screw**

Code	Length	Thread
A170	64mm	9.5mm
	76mm	9.5mm
	89mm	9.5mm
	102mm	9.5mm

**9 Forged Brass Table Sash Screw**

Code	Length	Thread
A175	64mm	8mm
	76mm	8mm
	89mm	8mm
	102mm	8mm



1 0818



2 2515



3 8140



4 0902



5 0885



6 0899



7 8892

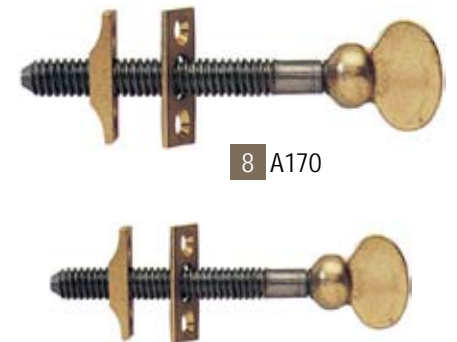

8 A170



9 A175



1 0907



2 0600

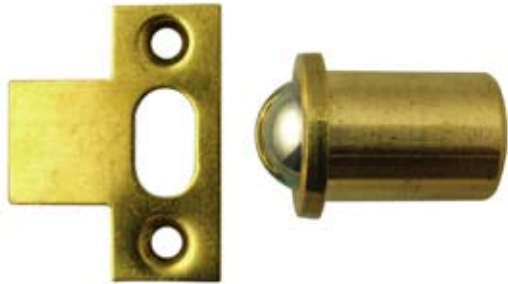

3 1107



4 1881



5 118



6 117

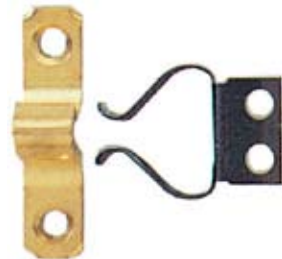

7 270



8 DOWEL

## 1 **Secrétaire Catch, Forged Brass**

Finishes: ANT, POL

Code	Height	Width
0907	44mm	25mm
	57mm	32mm
	67mm	35mm

## 2 **Counter Flap Catch** (see suitable 218 Hinge on page 89)

Finishes: POL, ANT, PCP, SCP

Code	Width	Length
0600	36mm	92mm

## 3

### **Brass ball catch**

Code	Diameter
1107	6mm
	7mm
	9mm
	13mm

## 4

### **Brass double ball Cupboard Catch**

Code	Height
1881	47mm

## 5

### **Light pressed brass Mirror Movement**

Code	Height
118	51mm

## 6

### **Brass-on-steel Movement for Victorian swivel Mirror**

Code	Height
117	41mm

## 7

### **Light pattern gripper Cupboard Catch**

Code	Height
270	32mm

## 8

### **Solid brass Table Locator Dowel**

Finish: Self Coloured

Code	Diameter
DOWEL	7mm



**1 Brass-on-steel Magnetic Cupboard Catch**

Finish: Self Coloured  
Code Width  
36LW 60mm

**2 Face-fix Magnetic Catch (single strength 4kg)**

Finishes: Chrome, Gilt, Nickel, Old Bronze  
Code Height Width  
LM5103 50mm 16mm

**3 Mortise Magnetic Catch (double strength 8kg)**

Finish: Nickel  
Code Height Width  
LM5202S 66mm 16mm

**4 Face-fix Magnetic Catch (double strength 8kg)**

Finishes: Chrome, Gilt, Nickel, Old Bronze effect, Wood effect  
Code Height Width  
LM5203 16mm 86mm

**5 Face-fix Magnetic Catch (single strength 4kg)**

Finishes: Brass, Nickel, Gilt, Chrome  
Code Height Width  
LM5402 50mm 16mm

**6 Face-fix Magnetic Catch (single strength 4kg)**

Finishes: Brass, Nickel, Self Colour.  
Code Height Width  
LM5601 60mm 15mm

**7 Silent Magnetic Catch (unique hidden magnets)**

Finishes: POL Brass, PCP, Black Nickel, Stainless Steel Effect  
Code Height Depth Width  
LEL01/2 42mm 11mm 16mm (5kg strength)  
63mm 12mm 16mm (8kg strength)



1 36LW



2 LM5103



3 LM5202S



4 LM5203



5 LM5402



6 LM5601



7 LEL01/2

**Easy Installation (LEL01/2 only)**

Installed by screwing a plastic housing onto the frame; then the decorative metal cover is clipped in place. All fixings are hidden, leaving a clean finish

**Silent Closure (LEL01/2 only)**

Unlike conventional magnetic catches there is no need for the catch to close directly onto a counter plate. The unique design will tolerate a small gap, which allows silent closure. This enables the introduction of a buffer system between catch and stile, providing a quiet but positive close.

# CASTORS

There is no range of fittings in this catalogue of which we are more proud.

The Armac castors are traditional in manufacture and application. They are expertly made and tested to be strong enough for all modern requirements.

They look stunning on heavy upholstered furniture or large ornate dining tables. Most of the styles date back to the 18th century and the squat versions 1342, 938 were popular in the Regency period. Brass wheels were popular until the Victorians decided to use white china porcelain wheels and later the Edwardians favoured the brown wheels, which are still very popular today. We have supplemented the Armac range with several castors designed for hardwood flooring. We have nylon wheels or wheels that hold a rubber tyre that should not mark or indent the wooden floorboards.



1 B1000



2 1033R



3 1033



4 1342

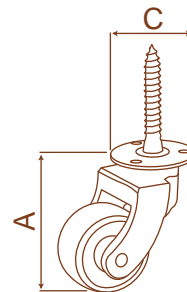
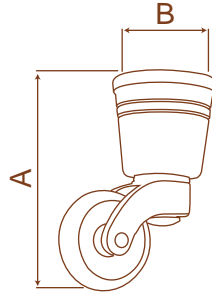
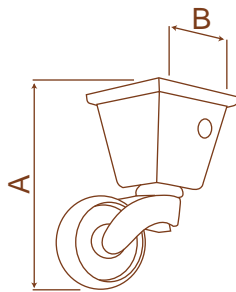
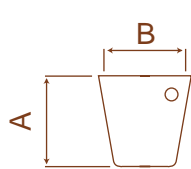

A = Overall Height    B = Internal Aperture Diameter    C = Plate Diameter

Please always refer to size B and/or C when ordering

## 1 Brass Screw Plate Castor (with brown china wheel)

Finishes: ANT, POL

Code	Plate Diameter	Height
B1000	25mm	38mm
	29mm	41mm
	32mm	45mm
	35mm	48mm
	38mm	51mm

## 2 Brass (3 Band Rubber Insert) Screw Castor

Finishes: POL, ANT

Code	Plate Diameter	Height
1033R	28mm	41mm
	32mm	45mm

## 3 Solid brass Screw Plate furniture Castor

Finishes: ANT, POL

Code	Plate Diameter	Height
1033	19mm	32mm
	22mm	35mm
	25mm	38mm
	28mm	41mm
	32mm	45mm
	35mm	48mm
38mm	51mm	

## 4 Solid brass, Squat design, Screw Plate Castor

Finishes: ANT, POL

Code	Plate Diameter	Height
1342	19mm	22mm
	22mm	22mm
	25mm	25mm
	29mm	25mm

**1 Brass Screw Plate Castor** (with white china wheel)

Finishes: ANT, POL

Code	Diameter	Height
W1000	25mm	38mm
	29mm	41mm
	32mm	45mm
	35mm	48mm
	38mm	51mm

**2 Solid rubber wheel Dinner Wagon Castor**

Finishes: ANT, POL

Code	Wheel Diameter	Height
1084	64mm	70mm

**3 Solid rubber wheel Trolley Castor with Grip Neck, push in socket fixing**

Code	Wheel Diameter	Height
1085	64mm	70mm

**4 Nylon Wheel & Brass Horn 6MA Fixing Castor**

Finishes: POL, ANT

Code	Height	Plate diameter
6688	35mm	19mm

**5 Brass Grip Neck Castor** (with white china wheel)

Finishes: ANT, POL

Code	Diameter	Height
W1001	25mm	38mm
	29mm	41mm
	32mm	45mm
	35mm	48mm
	38mm	51mm

**6 Brass Grip Neck Castor** (with brown china wheel)

Finishes: ANT, POL

Code	Diameter	Height
B1001	25mm	38mm
	29mm	41mm
	32mm	45mm
	35mm	48mm
	38mm	51mm

**7 Brass furniture Castor with Grip Neck, push in socket fixing**

Finishes: ANT, POL

Code	Height
1032	20mm
	25mm
	30mm
	36mm

**8 Brass (3 Band Rubber Insert) Grip Neck Castor**

Finishes: POL, ANT

Code	Height	Plate Diameter
GRIPP	38mm	28mm
	45mm	32mm



1 W1000



2 1084



3 1085



4 6688



5 W1001



6 B1001



7 1032



8 GRIPP



1 1324



2 1324



3 1326



4 1326



5 1321



6 1321



9 2430



7 1327



8 1327

## 1 Solid brass, Square Toe Castor

Finishes: ANT, POL

Code	Internal Aperture	Height
1324	19mm	48mm
	25mm	57mm
	29mm	67mm
	32mm	73mm
	35mm	83mm
	38mm	95mm
	45mm	95mm

## 2 Solid brass Square Toe castor Socket Only

Finishes: ANT, POL

Code	Internal Aperture
1324	19mm
	25mm
	29mm
	32mm
	35mm
	38mm

## 3 Solid brass Round Toe Castor

Finishes: ANT, POL

Code	Internal	Height
1326	29mm	64mm

## 4 Solid brass Round Toe castor Socket Only

Finishes: ANT, POL

Code	Internal
1326	29mm

## 5 Solid brass, Claw Toe Castor

Finishes: ANT, POL

Code	Internal Aperture	Height
1321	19mm	51mm
	25mm	57mm
	32mm	67mm
	35mm	83mm
	38mm	86mm
1321L	32mm	25mm

## 6 Solid brass Claw castor Body Only

Finishes: ANT, POL

Code	Internal Aperture
1321	19mm
	25mm
	32mm
	35mm
	38mm

## 7 Solid brass Reeded Toe Castor

Finishes: ANT, POL

Code	Internal	Height
1327	32mm	76mm

## 8 Solid brass Reeded Toe castor Socket Only

Finishes: ANT, POL

Code	Internal
1327	32mm

## 9 Brass lion Claw Shoe only

(3 sided with open base)

Finishes: ANT, POL

Code	Internal
2430	22mm
	32mm

**1 Brass Square Socket Castor** (with rubber tyre in wheel)

Finishes: POL, ANT

Code	Height	Internal Aperture Diameter
6622	70mm	24mm

**2 Nylon Wheel Brass Socket Castor**

Finishes: POL, ANT

Code	Height	Internal Aperture Diameter
6678	70mm	24mm

**3 Solid brass Tapered Square castor Socket Only**

Finishes: ANT, POL

Code	Internal Aperture	Height
929	16mm	16mm
	19mm	19mm
	22mm	22mm
	25mm	25mm
	29mm	29mm
	32mm	32mm
	35mm	35mm
	38mm	38mm

**4 Solid brass Tapered Square Socket Castor**

Finishes: ANT, POL

Code	Internal Aperture	Height
929	16mm	38mm
	19mm	45mm
	22mm	51mm
	25mm	57mm
	28mm	64mm
	32mm	70mm
	35mm	76mm
	38mm	83mm

**5 Solid brass, Square Socket Only**

Finishes: ANT, POL

Code	Internal Aperture	Height
938	19mm	28mm
	22mm	32mm
	25mm	32mm
	29mm	35mm

**6 Solid brass, Squat design, Square Socket Castor**

Finishes: ANT, POL

Code	Internal Aperture	Height
938	19mm	51mm
	22mm	54mm
	25mm	57mm
	29mm	57mm



1 6622



3 929



5 938



2 6678



4 929



6 938



1 834



2 W834



3 6659



4 6621



5 910



6 6620



7 907R

## 1 Brass Round Socket Cup Castor (with brown china wheel)

Finishes: ANT, POL

Code	Plate Diameter	Height
834	25mm	56mm
	29mm	64mm
	32mm	67mm
	35mm	72mm
	38mm	83mm

## 2 Brass Round Socket Cup Castor (with white china wheel)

Finishes: ANT, POL

Code	Internal aperture	Height
W834	25mm	56mm
	29mm	64mm
	32mm	67mm
	35mm	72mm
	38mm	83mm

## 3 Nylon Wheel Brass Socket Castor

Finishes: POL, ANT

Code	Height	Internal Aperture Diameter
6659	85mm	36mm

## 4 Brass Round Socket Castor (with rubber tyre in wheel)

Finishes: POL, ANT

Code	Height	Internal Aperture Diameter
6621	70mm	32mm

## 5 Brass Fluted Socket Castor

Finishes: POL, ANT

Code	Height	Internal Aperture Diameter
910	64mm	32mm

## 6 Nylon Wheel Brass Socket Castor

Finishes: POL, ANT

Code	Height	Internal Aperture Diameter
6620	70mm	32mm

## 7 Brass (3 Band Rubber Insert) Round Socket Castor

Finishes: POL, ANT

Code	Height	Internal Aperture Diameter
907R	64mm	28mm
	67mm	32mm

**1 Solid brass, Round Socket Cup Castor**

Finishes: ANT, POL

Code	Internal Aperture	Height
907	16mm	38mm
	19mm	45mm
	22mm	51mm
	25mm	56mm
	29mm	64mm
	32mm	67mm
	35mm	72mm
	38mm	83mm
	45mm	102mm

**2 Solid brass, Round Socket Cup Only**

Finishes: ANT, POL

Code	Internal Aperture	Height
907	16mm	16mm
	19mm	19mm
	22mm	22mm
	25mm	25mm
	29mm	29mm
	32mm	32mm
	35mm	35mm
	38mm	38mm
	45mm	45mm

**3 Sand cast brass Claw Foot**

(hollowed base style)

Finishes: ANT, POL

Code	Width of Claw
1301	22mm
	25mm
	32mm
	38mm
	51mm

**4 Sand cast brass Claw Foot**

(domed base style)

Finishes: ANT, POL

Code	Width of Claw
1302	22mm
	25mm
	32mm
	38mm
	51mm

**5 Brass decorative Round Castor Rim**

(for use with screw plate castors)

Finishes: ANT, POL

Code	Internal Aperture
2089C	19mm
	22mm
	25mm
	29mm
	32mm
	35mm
	38mm

**6 Brass decorative Square Castor Rim**

(for use with screw plate castors)

Finishes: ANT, POL

Code	Internal Aperture
2089S	22mm
	25mm
	29mm
	32mm
	35mm
	38mm



1 907



3 1301



4 1302



2 907



5 2089C



6 2089S

## TRAY HANDLES

An interesting selection of solid brass tray handles offering a variety of fixing methods sit curiously well alongside our solitary toilet seat handle.



1 1853



2 1943

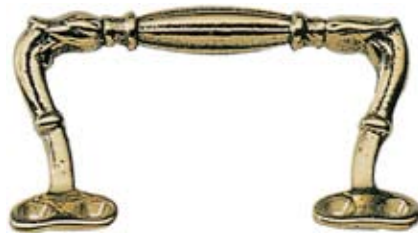

3 2292



4 2293



5 2294



6 4021

**1 Forged brass Butlers Tray Handle** (with decorative brass nut)

Finishes: ANT, POL.

Code	Width
1853	76mm

**2 Forged brass decorative Tray Handle**

Finishes: ANT, POL.

Code	Width
1943	76mm

**3 Sand cast brass Tray Handle**

Finishes: ANT, POL.

Code	Width
2292	86mm

**4 Forged brass Tray Handle**

Finishes: ANT, POL.

Code	Width
2293	76mm

**5 Sand cast brass Tray Handle**

Finishes: ANT, POL.

Code	Width
2294	76mm

**6 Sand cast brass Toilet Seat Lifting Handle**

Finishes: PCP, POL.

Code	Width
4021	44mm
	51mm



**1 Ball & Eagle design clock Ornament fitting**

Finish: POL

Code	Width	Height
0828	41mm	114mm
	51mm	121mm

**2 Ball & Spire design clock Ornament fitting**

Finish: POL

Code	Width	Height
828	41mm	105mm
	51mm	114mm

**3 Solid cast brass Corinthian Capitol for pillar clock fitting**

Finishes: ANT, POL

Code	Height	Diameter
0832	38mm	22mm

**4 Solid cast brass Sphinx Head decorative clock fitting**

Finish: POL

Code	Height	Width
2394	70mm	38mm

**5 Solid brass Ball Knob. Clock fitting or caddy feet**

Finish: POL

Code	Diameter
2994	13mm
	16mm
	19mm
	25mm

**6 Solid brass Ball Knob. Clock fitting or caddy feet**

Finish: POL

Code	Diameter
251	13mm
	19mm
	25mm

**7 Clock fitting. Solid cast brass Pillar Base**

Finishes: ANT, POL

Code	Height	Width
0898	16mm	22mm
	19mm	25mm

**8 Solid cast brass Sphinx Feet decorative clock fitting**

Finish: POL

Code	Width	Height
2411	38mm	83mm

Armac have always provided this small selection of items specifically intended for the restoration of grandfather clocks.

Whilst many of these items sell well we are kept equally busy by clock restorers requesting replica parts to be made using our lost-wax casting service.



1 0828



2 828



3 0832



4 2394



5 2994



6 251



7 0898



8 2411

# HINGES

A range of traditional design, surface mounted, cabinet hinges. The classic H-hinge, the ornate Snake hinge, the fancy Butterfly hinge, and the tiny Box hinge sit alongside the very popular butt hinges.

In addition to the cabinet hinges we also have the card table hinge that opens to 180 degrees, and the secretaire hinge that opens to 90 degrees, as well as a delightful clock case hinge and some quadrant style box hinges.



1 2228

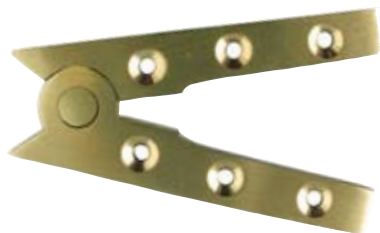

2 2248



3 2441



4 2527



5 2609



6 2840



7 4000



8 PH60

## 1 Forged brass Card Table Hinge (opens to 180 degrees)

Finish: SAN

Code	Height	Width open
2228	35mm	64mm
	35mm	76mm

## 2 Forged brass Secretaire Hinge (opens to 90 degrees)

Finish: SAN

Code	Height	Width open
2248	25mm	76mm

## 3 Sand cast brass Snake Hinge (decorative cabinet hinge)

Finishes: ANT, POL

Code	Height	Width
2441	64mm	48mm
	76mm	45mm
	89mm	60mm
	102mm	60mm

## 4 Forged brass 'H' Hinge (decorative cabinet hinge)

Finishes: ANT, POL, PCP, SCP

Code	Height	Width open
2527	51mm	32mm
	64mm	35mm
	76mm	35mm
	89mm	38mm
	102mm	38mm
	127mm	44mm

## 5 Sand cast brass Butterfly Hinge (cabinet hinge)

Finishes: ANT, POL

Code	Height	Width open
2609	95mm	76mm

## 6 Sand cast brass Clock Case Hinge

Finish: POL

Code	Height	Width
2840	32mm	35mm

## 7 Sand cast brass decorative Box Hinge

Finish: ANT

Code	Height	Width open
4000	19mm	14mm

## 8 2 metre lengths of continuous Piano Hinge

(available in solid brass, plated steel finishes of bronze and electro brass) Please state finish required

Finishes: e.b., f.b., s.b.

Code	Width open
PH60	25mm
	32mm
	38mm

**1 Extruded brass Clock Case Hinge**

Finish: POL

Code	Height	Width open
1521	25mm	35mm
	32mm	35mm

**2 Solid drawn brass Butt Hinge (standard pattern)**

Finish: Self Col

Code	Height	Width open
204	25mm	16mm
	38mm	22mm
	51mm	28mm
	64mm	35mm
	76mm	41mm

**3 Solid extruded brass Broad Butt Hinge (cabinet hinge)**

Finishes: ANT, PCP, POL, SCP, SNP

Code	Height	Width open
207	38mm	25mm
	51mm	32mm
	51mm	38mm
	64mm	38mm
	76mm	48mm

**4 Solid drawn brass Butt Hinge (adjustable slots)**

Finish: Self Col

Code	Height	Width open
204SLOT	51mm	28mm
	64mm	35mm

**5 Solid drawn brass Flush Hinge (adjustable slots)**

Finish: Self Col

Code	Height	Width open
290	51mm	34mm
	64mm	34mm

**6 Solid drawn brass Back Flap Hinge**

Finish: Self Col

Code	Height	Width open
210	32mm	48mm
	38mm	60mm
	51mm	76mm

**7 Solid drawn brass Strap Hinge**

Finish: Self Col

Code	Height	Width open
215	13mm	76mm
	13mm	102mm
	16mm	127mm

**8 Brass Quadrant Casement Hinge (with stop for cutlery and jewel boxes)**

Finish: Self Col

Code	Height	Width closed
214	5mm	48mm

**9 Pressed brass Case and Jewel Box Hinge**

Finish: Self Col

Code	Height	Width open
213	34mm	64mm

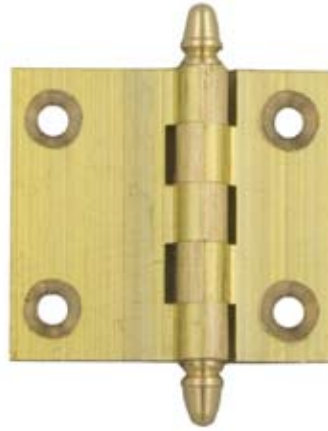

1 1521



2 204



3 207



4 204SLOT



5 290



6 210



7 215



8 214



9 213



1 216



2 217



3 218



4 220



5 2300



6 2301B



7 2301A

**1 Pressed brass Quadrant Hinge**  
(with stop at approx 110 degrees)  
Finish: Self Col  
Code Height Width closed  
216 30mm 42mm

**2 Pressed brass Quadrant Hinge**  
(with stop at approx 110 degree)  
Finish: Self Col  
Code Height Width closed  
217 26mm 34mm

**3 Solid drawn brass Counter Flap Hinge**  
Finish: POL  
Code Height Width open  
218 25mm 76mm  
32mm 102mm  
38mm 114mm

**4 Solid drawn brass Centre Hinge**  
Finish: Self Col  
Code Height Width open  
220 13mm 51mm  
13mm 64mm

**5 Solid drawn brass Cabinet Hinge with button tip ends.**  
(Decorative finials can be ordered separately 2301A, 2301B)  
Finish: POL, PCP, SAT, SCP (Illustrated PCP)  
Code Height Width open  
2300 38mm 38mm  
50mm 38mm  
50mm 50mm  
64mm 50mm  
64mm 64mm  
76mm 50mm

**6 Pillar Finial for use on hinge 2300**  
Finishes: PCP, POL, SAT, SCP  
Code Height  
2301B 22mm

**7 Ball Finial for use on hinge 2300**  
Finishes: PCP, POL, SAT, SCP  
Code Height  
2301A 10mm

**1 Solid drawn brass Counter Flap Hinge**

( see suitable catch 0600 )

Finish: Self Col

Code	Height	Width open
0610	38mm	101mm



1 0610

**2 Solid drawn brass Card Table Hinge (flush fixing)**

Finish: Self Col

Code	Height	Width open
250	13mm	76mm



2 250

**3 Solid drawn brass Butlers Tray Hinge**

Finish: Self Col

Code	Height	Width open
289	32mm	64mm
	38mm	64mm

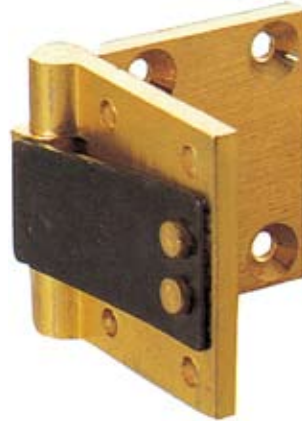

3 289

**4 Solid drawn brass Table Hinge (odd sided rule joint pattern)**

Finish: Self Col

Code	Height	Width open
301T	32mm	54mm
	38mm	73mm

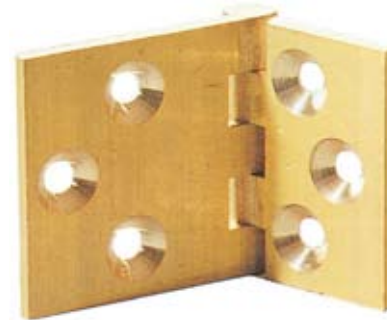

4 301T

**5 Brass Screen Hinge (for freestanding screens)**

Finish: Self Col

Code	Height	Width open
5817	51mm	48mm



5 5817

**6 Brass Strap Hinge Light Pattern**

Code	Height	Width open
N04	9mm	51mm
	13mm	64mm



6 N04

**7 Brass Cylinder Hinge**

Code	Diameter
N1128	10mm
	12mm
	14mm
	16mm



7 N1128

# ARCHITECTURAL HINGES

These are all precision made hinges of the highest quality for the most critical of joinery and specialist applications.

All available to order in the following finishes: POL BRASS, SATIN BRASS, SATIN CHROME, POL CHROME and IMITATION BRONZE.



1 H1450



2 H1550



3 H1650



4 H4660BUT



5 H4660URN



6 H4660BALL



7 H1262A

## 1 Finial Brass Butt and projection Hinge

Code	Height	Width
H1450	75mm	50mm
	100mm	65mm
	100mm	75mm
	100mm	100mm
	100mm	125mm
	100mm	150mm
	100mm	200mm
	15mm	75mm
	150mm	75mm
	150mm	100mm

Other sizes available to order

## 2 4 Ball Race Brass Butt and projection Hinges

Code	Height	Width
H1550	100mm	65mm
	100mm	75mm
	100mm	100mm

Other sizes available to order

## 3 Ball Race Finial Brass Butt and projection Hinge

Code	Height	Width
H1650	100mm	65mm
	100mm	75mm
	100mm	100mm

Other sizes available to order

## 4 Ball Race Brass Feature Projection Hinge (button tips)

Code	Height	Width
H4660BUT	76mm	76mm
	89mm	89mm
	100mm	89mm
	102mm	102mm
	114mm	114mm

## 5 Ball Race Brass Feature Projection Hinge (urn finials)

Code	Height	Width
H4660URN	76mm	76mm
	89mm	89mm
	100mm	89mm
	102mm	102mm
	114mm	114mm

## 6 Ball Race Brass Feature Projection Hinge (ball finials)

Code	Height	Width
H4660BALL	76mm	76mm
	89mm	89mm
	100mm	89mm
	102mm	102mm
	114mm	114mm

## 7 Brass Butt and projection hinge

(double phosphor bronze washered)

Code	Height	Width
H1262A	75mm	50mm
	100mm	65mm
	100mm	75mm
	100mm	100mm
	100mm	125mm
	100mm	150mm
	100mm	200mm
	125mm	75mm
	150mm	75mm
	150mm	100mm

All H4660 Hinges are ANSI Approved

**1 Brass Security Bolt Hinge Phosphor Bronze Washered**

Code	Height	Width
H1250	100mm	75mm

**2 Brass Rising Butt Hinge**

(suitable for toilet door and similar applications)  
These hinges are handed left and right

Code	Width	Height
H1840	67mm	76mm
	67mm	102mm

**3 Brass Falling Hinge** (these hinges are handed left and right)

Code	Width	Height
H1841	65mm	75mm
	75mm	100mm

Left Hand : Clockwise Closing

Right Hand : Anti Clockwise Closing

**4 Heavy duty solid brass Parliament Projection Hinge for conservatory door and other applications**

(designed to carry lightweight doors up to 30kg max)

Code	Height	Width	Projection
H560	102mm	64mm	64mm
	102mm	76mm	75mm
	102mm	102mm	100mm

**5 Brass Lift Off Hinge**

(these hinges are handed left and right)

Code	Height	Width
H901	76mm	41mm
	76mm	51mm

**6 Brass Samson Performance Hinge**

(25 year guarantee, maintenance free)

Main image shown with standard tips

Code	Height	Width
H1880	88mm	100mm

**6a** Designer Finial Option H1880 Star

**6b** Designer Finial Option H1880 Top

**6c** Designer Finial Option H1880 Soft

**Tectus 3D**

Three Way Adjustable Concealed Hinge

Finishes: Matt Chrome effect, Matt Nickel effect, Stainless Steel effect

Fixing screws not supplied

Intumescent kits available.

510 version fire tested to BSEN 1634 1/2 Hour

Code	Height	Width
<b>7</b> 5103D	180mm	30mm
<b>8</b> 2103D	140mm	21mm



1 H1250

2 H1840

3 H1841

4 H560

5 H901



6a

6b

6c



6 H1880



7 5103D



8 2103D

# DOOR KNOCKERS

Armac have always made and sold door knockers but they have never featured in the main catalogue until now. All are solid sand-cast brass made at our own foundry and each one is finished and assembled by hand.

Like the escutcheon pages, this is only a small selection of the full range of patterns available, but we hope we have selected enough that should appeal to most people. Our entire door knocker range is hand made from sand castings at the Armac Brassworks.



1 KNK10



2 K012



3 K106



4 K072



5 K032



6 K033



7 K116



8 K107

## 1 Valentine Door knocker

Code	Height	Width
KNK10	115mm	76mm

## 2 Cherub Door Knocker

Code	Height	Width
K012	152mm	89mm

## 3 Double Horse Shoe Door Knocker

Code	Height	Width
K106	114mm	102mm

## 4 Medusa Door Knocker

Solid cast brass.		
Code	Height	Width
K072	165mm	127mm

## 5 Fox Door Knocker

Code	Height	Width
K032	159mm	60mm

## 6 Large Fox Door Knocker

Code	Height	Width
K033	254mm	102mm

## 7 Masonic Door Knocker

Code	Height	Width
K116	127mm x 127mm	

## 8 Grecian Urn Door Knocker

Code	Height	Width
K107	178mm	102mm



**1 No.10 Downing Street, Lion Head Door Knocker**

Code	Height	Width
K057	229mm	121mm

**2 3-Part Lion Head Door Knocker**

Code	Height	Width
K061	197mm	114mm

**3 Large Lion Mask Door Knocker**

Code	Height	Width
K064	280mm	203mm

**4 2-Part Lion Head Door Knocker**

Code	Height	Width
K080	178mm	102mm

**5 Small Lincoln Imp Door Knocker**

Code	Height	Width
K054	120mm	32mm

**6 Large Lincoln Imp Door Knocker**

Code	Height	Width
K056	140mm	57mm

**7 Shamrock Claddagh Door Knocker**

Code	Height	Width
K095	112mm	116mm

**8 Scottish Piper Door Knocker**

Code	Height	Width
K092	139mm	52mm

**9 Jenny Jones Door Knocker**

Code	Height	Width
K051	108mm	51mm

**10 Pineapple Door Knocker**

Code	Height	Width
K079	152mm	95mm

**11 Large Pixie Door Knocker**

Code	Height	Width
K081	146mm	63mm

**12 Welsh Dragon Door Knocker**

Code	Height	Width
KNK05	120mm	57mm



1 K057



2 K061



3 K064



4 K080



5 K054



6 K056



10 K079



7 K095



11 K081



8 K092



12 KNK05



9 K051

# DOOR KNOCKERS



1 K096



2 K093



3 K118



4 K004



5 K005



6 K022



7 K019



8 WB01



9 K073



10 K097



11 WB0



12 DB01

## 1 Shell Door Knocker

Code	Height	Width
K096	184mm	76mm

## 2 Sea Horse Door Knocker

Code	Height	Width
K093	139mm	52mm

## 3 Anchor & Life Belt Door Knocker

Code	Height	Width
K118	146mm	105mm

## 4 Medium Anchor Door Knocker

Code	Height	Width
K004	127mm	63mm

## 5 Large Anchor Door Knocker

Code	Height	Width
K005	178mm	89mm

## 6 Maltese Dolphin Door Knocker

Code	Height	Width
K022	234mm	82mm

## 7 Dolphin Door Knocker

Code	Height	Width
K019	177mm	57mm

## 8 Anchor Porch Bell

Finish: POL		
Code	Height	Width
WB01	178mm	89mm

## 9 Norseman Door Knocker

Code	Height	Width
K073	139mm	95mm

## 10 Galleon Door Knocker

Code	Height	Width
K097	152mm	89mm

## 11 Wall Mounted Ships Bell

Finish: POL		
Code	Width	
WB0	89mm	
	127mm	
	152mm	

## 12 Victorian Counter Desk Bell

Finish: POL		
Code	Height	Width
DB01	76mm	102mm

Supplied in 1 metre lengths

**1 Decorative brass malleable mouldings**

Code Width  
M814 10mm

**2 Decorative brass malleable mouldings**

Code Width  
M815 10mm

**3 Decorative brass malleable mouldings**

Code Width  
M816 10mm

**4 Decorative brass malleable mouldings**

Code Width  
M819 10mm

**5 Decorative brass malleable mouldings**

Code Width  
M820 8mm

**6 Decorative brass malleable mouldings**

Code Width  
M821 4mm

**7 Decorative brass malleable mouldings**

Code Width  
M832 6mm

**8 Decorative brass malleable mouldings**

Code Width  
M833 3mm

**9 Decorative brass malleable mouldings**

Code Width  
M834 7mm

**10 Decorative brass malleable mouldings**

Code Width  
M835 4mm

**11 Decorative brass malleable mouldings**

Code Width  
M836 4mm

**12 Decorative brass malleable mouldings**

Code Width  
M838 8mm

**13 Decorative brass moulding with a ribbon and bow pattern**

Code Width  
M842 5mm

Ornamental Mouldings, Gallery & Strip

A selection of brass malleable mouldings, embellishments, decorative strip and brass gallery railings.

The mouldings are Antique Brass, and sold in 1 metre lengths. The strip and gallery are self colour brass, and the ornaments are lightweight pressings that need to be secured with a brass pin.

These are essential items for the restoration and renovation of ornate furniture.



1 M814 2 M815 3 M816 4 M819 5 M820 6 M821 7 M832 8 M833 9 M834 10 M835 11 M836 12 M838 13 M842



1 R087



2 R088



3 R269



4 R270



5 R872



6 R873



7 R198



9 R874



10 R875



11 R876



8 R877



12 R880

**1 Stamped brass decorative ornament face pin fixed**

Code	Width	Height
R087	18mm	83mm

**2 Stamped brass decorative ornament face pin fixed**

Code	Width	Height
R088	16mm	74mm

**3 Very light pressed brass decorative ornament face pin fixed**

Code	Width	Height
R269	13mm	77mm

**4 Very light pressed brass decorative ornament face pin fixed**

Code	Width	Height
R270	17mm	97mm

**5 Very light pressed brass decorative ornament face pin fixed**

Code	Width	Height
R872	42mm	75mm

**6 Very light pressed brass decorative ornament face pin fixed**

Code	Width	Height
R873	23mm	88mm

**7 Very light pressed brass decorative ornament face pin fixed**

Code	Width	Height
R198	75mm	8mm

**8 Very light pressed brass decorative ornament face pin fixed**

Code	Width	Height
R877	19mm	

**9 Very light pressed brass decorative ornament face pin fixed**

Code	Height	Width
R874	25mm	25mm

**10 Very light pressed brass decorative ornament face pin fixed**

Code	Width	Height
R875	29mm	

**11 Very light pressed brass decorative ornament face pin fixed**

Code	Width	Height
R876	27mm	

**12 Decorative brass rosette pin fix very light pattern pressed**

Finish:	Code	Width
	R880	20mm

**1 Straight brass Post for use with gallery rod pattern POSR**

Finish: POL  
Code Height  
POSS 25mm

**2 Turned brass Corner Post used with POSR rod to make gallery rail**

Finish: POL  
Code Height  
POSC 25mm

**3 Turned brass End Post for use with POSR rod as gallery rail**

Finish: POL  
Code Height  
POSE 25mm

**4 Solid brass Rod 3/8" diameter used as gallery rail with POSR, POSC and POSS (supplied in 5ft lengths)**

Finish: POL  
Code Diameter  
POSR 4.75mm

**5 No.1 Brass Astragal Strip (2 metre lengths)**

Decorative door edging strip solid brass  
Finish: Self Colour Brass  
Code Width Height  
ASTR1 5mm 9mm

**6 Pierced solid brass Arched Gallery Rail**

suitable for davenport desk edging and decorative tray  
use supplied in 2.13 m (7 ft) lengths  
Finish: Self Colour Brass  
Code Height  
GALLE 22mm

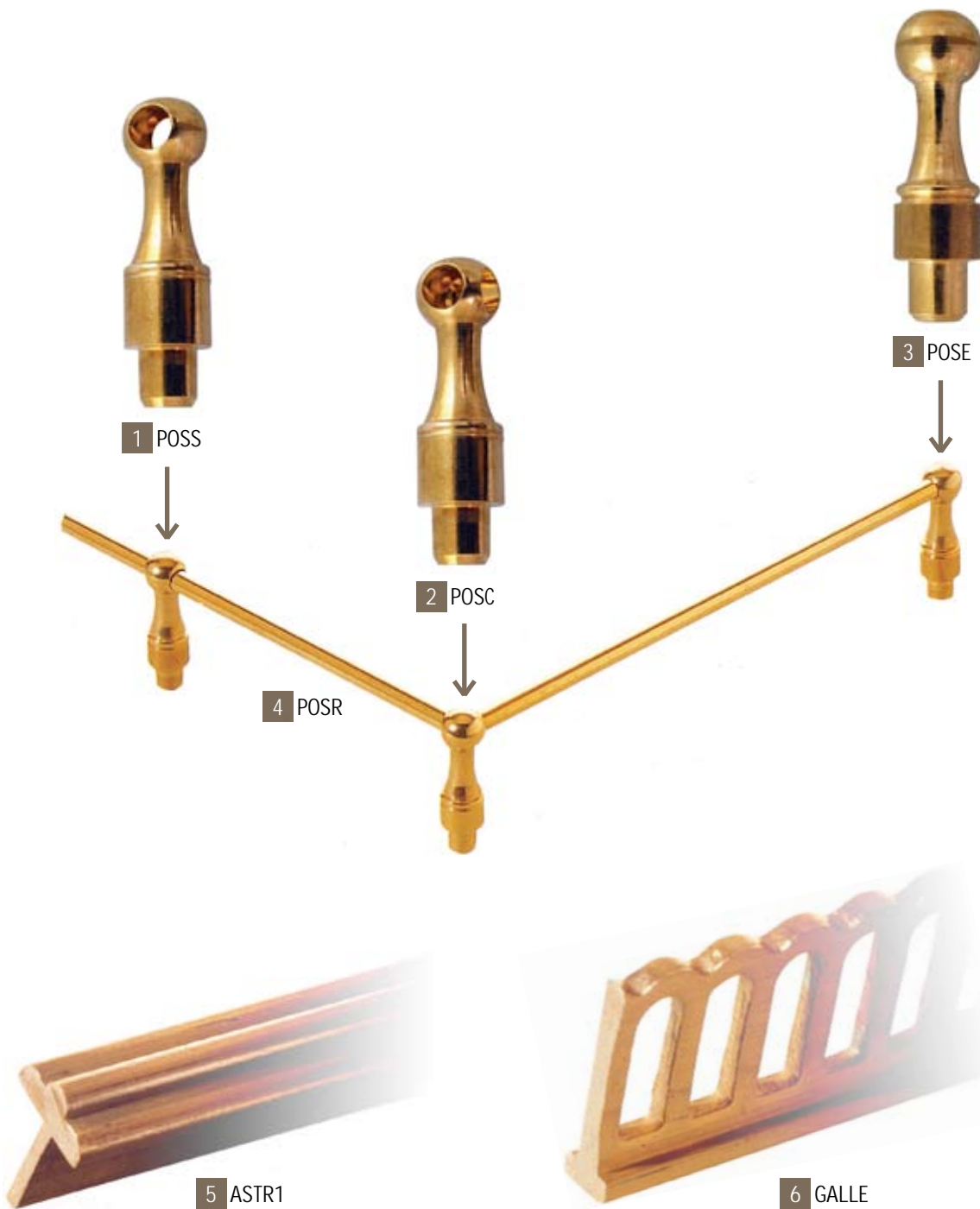

5 ASTR1

6 GALLE

# LOCKS

Every new catalogue has seen the expansion of our lock section and this edition is no exception. Additions for most of our popular locks are often requested extra sizes and a greater variety of pin distances (of great benefit to restorers). The jewel box lock and bureau lock are also of particular interest to specialist box and furniture manufacturers.

## Opening Cupboard Doors

Lock showing left hand position. The diagram illustrates the hand of locks fitted in the cut, rim or mortice position. Bolt shoots to left when locked.

## Opening Cupboard Doors

Lock showing right hand position. The diagram illustrates the hand of locks fitted in the cut, rim or mortice position. Bolt shoots to right when locked.

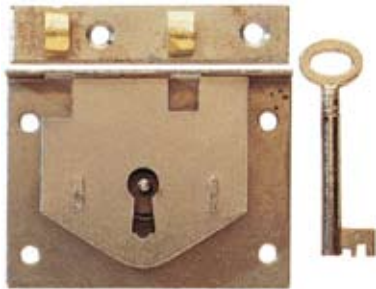
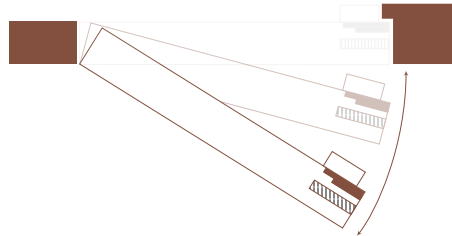
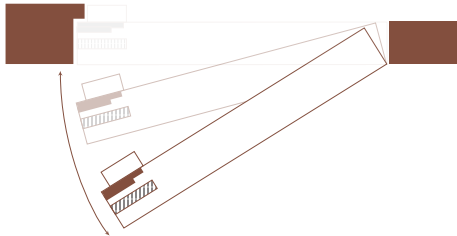

1 120



2 121



3 122

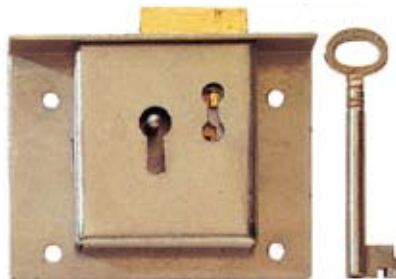

4 1903



5 241

### 1 Steel Chest Lock (complete with one key and striking plate)

Code	Width	Height	Distance to pin
120	76mm	57mm	32mm
	89mm	57mm	32mm
	102mm	57mm	32mm

### 2 Steel Chest Lock (2 levers, to pass 1 key) Self colour or black japanned. (illustrated)

Code	Width	Height	Distance to pin
121	76mm	58mm	31mm
	89mm	58mm	31mm
	102mm	58mm	31mm

### 3 Brass Chest Lock (2 levers, 2 keys)

Code	Width	Height	Distance to pin
122	76mm	56mm	31mm
	89mm	56mm	31mm
	102mm	56mm	31mm

### 4 Steel Drawer Till Lock

(with 1 lever and 1 key no striking plate supplied)

Code	Width	Height	Distance to pin
1903	64mm	57mm	22mm
	70mm	57mm	22mm
	76mm	57mm	22mm

### 5 Solid brass 2 lever cupboard or Till Lock

(with 2 keys, no striking plate supplied)

Code	Width	Height	Distance to pin
241	38mm	32mm	13mm
	51mm	38mm	16mm
	64mm	42mm	19mm
	70mm	48mm	19mm
	76mm	48mm	19mm

We have a selection of striking plates cut and plain to suit most drawer and cupboard locks if required.

We are able to supply locks to suite and in some patterns master keyed.

A suite of Cut Drawer Locks incorporating drawer, cut cupboard left and right hand, straight cupboard (all to pass the same key patt no. 240E on page 104. Please order separately)  
No striking plates supplied

**1 Cut Drawer Lock. Left hand**

Code	Height	Width	Distance to pin
240B	64mm	38mm	19mm

**2 Cut Drawer Lock. Right hand**

Code	Height	Width	Distance to pin
240C	64mm	38mm	19mm

**3 Straight Cupboard Lock**

Code	Height	Width	Distance to pin
240D	64mm	32mm	16mm

**4 Drawer Lock**

Code	Height	Width	Distance to pin
240A	48mm	64mm	19mm

**5 Brass Cut Cupboard Lock**

(this lock is handed) 2 lever 2 keyed cut/ flush cupboard lock no striking plate supplied

Code	Width	Height	Distance to pin
243	25mm	38mm	13mm
	32mm	51mm	13mm
	38mm	64mm	16mm
	41mm	76mm	20mm

**6 Brass 2 lever 2 key Box Lock (with striking plate)**

Code	Width	Height	Distance to pin
245	38mm	28mm	16mm
	51mm	32mm	19mm
	64mm	38mm	22mm
	76mm	41mm	25mm

**7 Brass, face fix, double handed, 2 lever, Straight Cupboard Lock (with 2 keys)**

No striking plate supplied

Code	Height	Width	Distance to pin
248	38mm	22mm	11mm
	51mm	28mm	15mm
	64mm	35mm	18mm
	76mm	35mm	20mm

**8 Solid brass, Full Mortice Cupboard Lock**

(2 lever 2 keys no striking plate supplied). This lock is handed left and right. Please state hand required

Code	Height	Width	Distance to pin
262	51mm	25mm	13mm
	64mm	35mm	16mm
	76mm	41mm	19mm



1 240B



2 240C



3 240D



4 240A



5 243

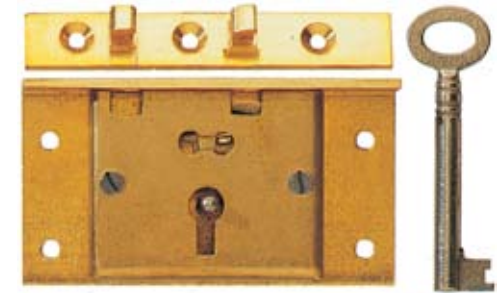

6 245

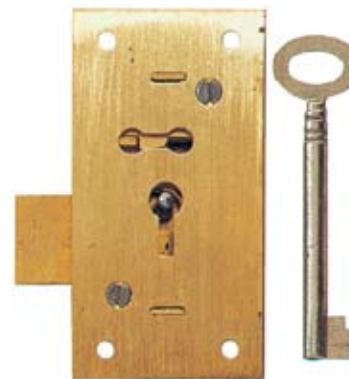

7 248



8 262



1 381

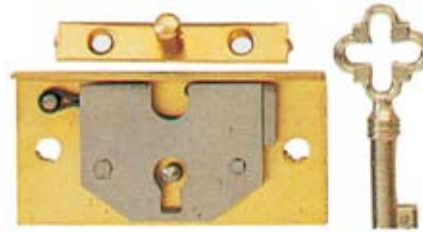

2 380

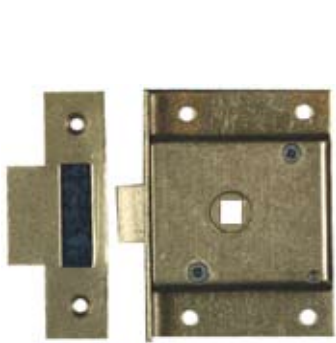

3 419



4 420



5 422

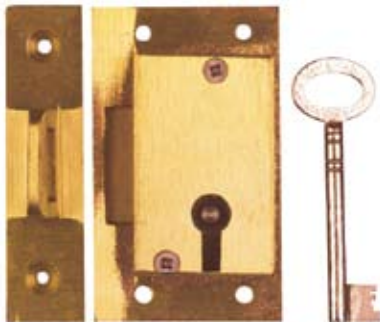

6 423



7 426

**1 Jewel Case Lock** (heavy pattern, 2 levers, 2 keys)  
Code Width Height Distance to pin  
381 38mm 20mm 13mm

**2 Jewel Box Lock** (light pattern single fancy key)  
Code Width Height Distance to pin  
380 42mm 22mm 15mm

**3 Spring Latch**  
Code Height Width Distance to pin  
419 64mm 48mm 22mm

**4 Brass Hook Bolt Mortice Lock** (this lock is handed. L/H illustrated)  
2 lever, with 2 keys and striking plate suitable for sliding door and similar applications  
Code Height Width Distance to pin  
420 64mm 35mm 16mm  
76mm 38mm 22mm

**5 Brass Hook Bolt Lock** (this lock is handed. L/H illustrated)  
2 lever, with 2 keys and locating plate suitable for sliding door and similar applications  
Code Height Width Distance to pin  
422 51mm 32mm 12mm  
64mm 38mm 16mm  
76mm 41mm 21mm

**6 Solid brass Link Plate Lock** (this lock is handed. L/H illustrated)  
3 lever, with 2 keys and striking plate for plant on door applications and davenport lock  
Code Height Width Distance to pin  
423 38mm 64mm 14mm

**7 Showcase Mortice Lock** (this lock is handed. L/H illustrated)  
1 lever, 2 keyed no striking plate supplied  
Code Height Width Distance to pin  
426 38mm 19mm 11mm  
51mm 19mm 11mm



**1 Showcase Mortice Lock** (this lock is handed. L/H illustrated)

1 lever, 2 keyed no striking plate supplied

Code	Height	Width	Distance to pin
427	38mm	19mm	11mm
	51mm	19mm	22mm



1 427

**2 Brass Straight Cupboard Showcase Lock** (double handed)

Double handed with 2 key no striking plate supplied

Code	Height	Width	Distance to pin
428	38mm	19mm	10mm
	51mm	19mm	10mm



2 428

**3 Brass single lever Showcase and small box Lock with 2 decorative keys and striking plate**

Code	Width	Height	Distance to pin
431	38mm	19mm	13mm
	51mm	19mm	13mm

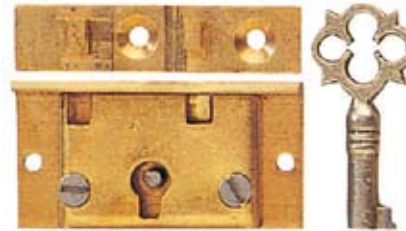

3 431

**4 Brass Straight Cupboard Lock**

Light pattern double handed with 1 key, no striking plate supplied

Code	Height	Width	Distance to pin
490	38mm	19mm	10mm
	51mm	28mm	13mm
	64mm	32mm	16mm
	76mm	38mm	18mm



4 490

**5 Brass Straight Cupboard Lock**

Heavy pattern, 1 lever, 2 keys with screw cap, no striking plate

Code	Height	Width	Distance to pin
491	38mm	23mm	11mm
	51mm	29mm	14mm
	63mm	37mm	18mm
	76mm	37mm	18mm



5 491

**6 Brass Cut Cupboard Lock** (this lock is handed. L/H illustrated)

Single lever, inset cut, flush, with one key no striking plate supplied

Code	Height	Width	Lock distance to pin
570	38mm	25mm	13mm
	51mm	28mm	13mm
	64mm	32mm	16mm
	76mm	38mm	18mm



6 570

**7 Brass cap, single lever light pattern Box Lock with one key and striking plate**

Code	Width	Height	Distance to pin
572	38mm	25mm	16mm
	51mm	32mm	19mm
	64mm	35mm	22mm
	76mm	38mm	24mm

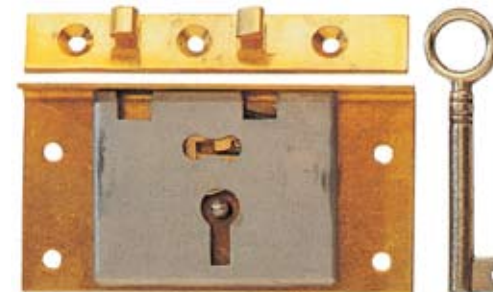

7 572

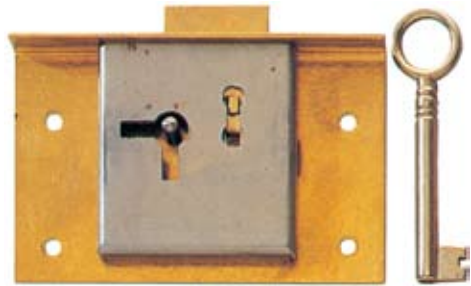

1 575

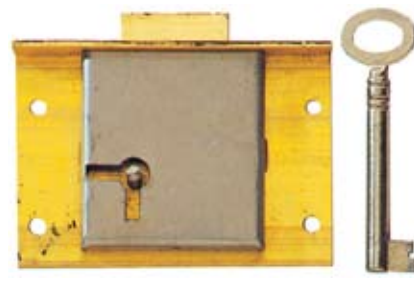

2 575S

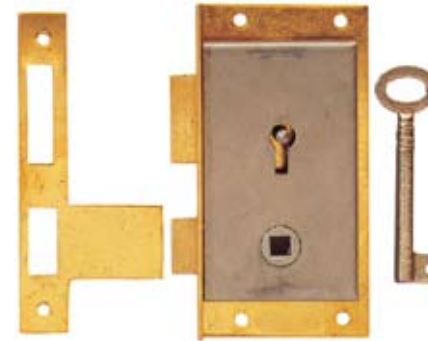

3 878



4 903

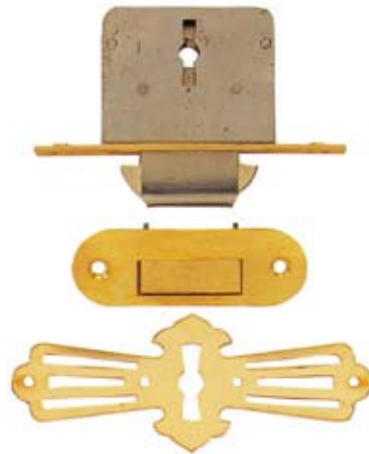

5 3161



6 402

**1 Brass Till Lock, light pattern, single lever with one key, no striking plate supplied**

Code	Width	Height	Distance to pin
575	38mm	32mm	13mm
	51mm	38mm	16mm
	64mm	48mm	19mm
	76mm	48mm	19mm

**2 Brass Till Lock, light pattern, single lever with one key, no striking plate supplied**

Code	Width	Height	Distance to pin
575S (20dtp)	63mm	48mm	28mm
	70mm	48mm	28mm
	76mm	48mm	28mm
576 (As above but different dtp)	63mm	48mm	32mm
	70mm	48mm	32mm
	76mm	48mm	32mm

**3 Brass Wardrobe lock** (this lock is handed left or right. L/H illustrated)

1 lever 2 keyed suitable for use with wardrobe handles 1686, 1701, 685 etc

Code	Height	Width	Distance to pin
878	89mm	45mm	22mm

**4 Steel Straight Cupboard Lock, double handed with 1 key, no striking plate supplied**

Code	Height	Width	Distance to pin
903	76mm	54mm	27mm
	89mm	54mm	27mm
	102mm	54mm	27mm
904	56mm	33mm	16mm
	66mm	33mm	16mm
905	66mm	41mm	21mm
	76mm	41mm	21mm

**5 Roll Top Desk Lock with 2 keys** (with decorative Victorian escutcheon and spring loaded striking plate)

Code	Height	Width	Distance to pin
3161	80mm	38mm	25mm

**6 Bureau Lock** (left hand only as illustrated)

2 lever, 2 keys with sloping selvage at 120 degree angle

Code	Height	Width	Distance to pin
402	51mm	29mm	12mm

**1 Lost wax fine nickel iron reproduction key blanks**

Code Length  
KKBN1 70mm

**11 Brass classic design decorative key blank centre drilled**

Finish: POL  
Code Length  
26/35 67mm

**2 Lost wax fine nickel iron reproduction key blanks**

Code Length  
KKBN2 54mm

**12 Suited Cut Key for 240 suite locks on Page 100**

Finish: POL  
Code Length  
240E 57mm

**3 Lost wax fine nickel iron reproduction key blanks**

Code Length  
KKBN3 51mm

**13 Brass decorative key blank**

Finish: POL  
Code Length  
240F 57mm

**4 Lost wax fine nickel iron reproduction key blanks**

Code Length  
KKBN4 51mm

**14 Solid brass key blank**

Finish: POL  
Code Length  
16/32 73mm

**5 Lost wax fine nickel iron reproduction key blanks**

Code Length  
KKBN5 45mm

**15 Iron key blanks for cutting to pattern centre drilled**

Code Length  
KKB5 38mm

**6 Lost wax fine nickel iron reproduction key blanks**

Code Length  
KKBN6 38mm

**16 Iron key blanks for cutting to pattern centre drilled**

Code Length  
KKB6 32mm

**7 Lost wax fine nickel iron reproduction key blanks**

Code Length  
KKBN7 35mm

**17 Iron key blanks for cutting to pattern centre drilled**

Code Length  
KKB7 25mm

**8 Lost wax fine nickel iron reproduction key blanks**

Code Length  
KKBN8 28mm

**18 Iron fancy bow key blank antique finish**

Code Length  
KBS1 60mm

**9 Lost wax fine nickel iron reproduction key blanks**

Code Length  
KKBN9 25mm

**19 Iron fancy bow key blank antique finish**

Code Length  
KBS2 60mm

**10 Brass decorative key blank**

Finish: POL  
Code Length  
33/40 67mm



1 KKBN1



2 KKBN2



3 KKBN3



4 KKBN4



5 KKBN5



6 KKBN6



7 KKBN7



8 KKBN8



9 KKBN9



10 33/40



11 26/35



12 240E



13 240F



14 16/32



15 KKB5



16 KKB6



17 KKB7



18 KBS1



19 KBS2

# BOLTS

Here we offer a splendid range of solid brass furniture and barrel bolts. All are produced from original tooling in our own factory in Birmingham. Each bolt is quality checked to ensure a neat smooth action and a superior finish, even the barrel bolts are hand polished! The rivetting, the springs used, the finish, and the action of the bolt itself make these an excellent range of quality products.

The bolts shown here cover a range of applications for internal cupboards or wardrobes to surface mounted decorative fittings. All are supplied with quality woodscrews and striking plates.

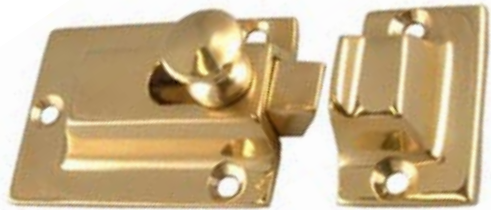

1 8895



2 1744



3 1791



4 7302



5 6032



6 6038

## 1 Solid brass, Arts & Crafts Cupboard Bolt

Finishes: ANT, POL, PCP, PNP, SCP, SNP

Code	Height	Width
8895	34mm	37mm

## 2 Solid brass Sliding Flush Bolt

Finishes: ANT, POL

Code	Height	Width
1744	83mm	28mm
	89mm	28mm

## 3 Solid cast brass Sliding Neck Bolt

Finishes: ANT, POL

Code	Height	Width
1791	64mm	10mm
	76mm	12mm

## 4 Solid forged brass Flush Bolt

(thumb action stands 3mm proud)

Finish POL

Code	Width	Height
7302	13mm	76mm

## 5 Solid extruded brass Flat Cupboard Bolt

Code	Height	Width
6032	51mm	14mm

## 6 Solid Extruded brass Flat Cupboard Bolt

Code	Height	Width
6038	64mm	16mm
	76mm	16mm

**Superior quality, fully extruded, straight brass Barrel Bolt**

Finishes: ANT, POL

Code	Width	Length
1 6906	25mm	51mm
	25mm	64mm
	25mm	76mm
2 7706	32mm	102mm
	32mm	153mm
	32mm	204mm
	32mm	306mm

**Superior quality, fully extruded, necked Barrel Bolt**

Code	Width	Length
3 6907	25mm	76mm
	25mm	102mm
	25mm	152mm
4 7707	32mm	102mm
	32mm	152mm
	32mm	203mm
	32mm	254mm
	32mm	305mm



1 6906



2 7706

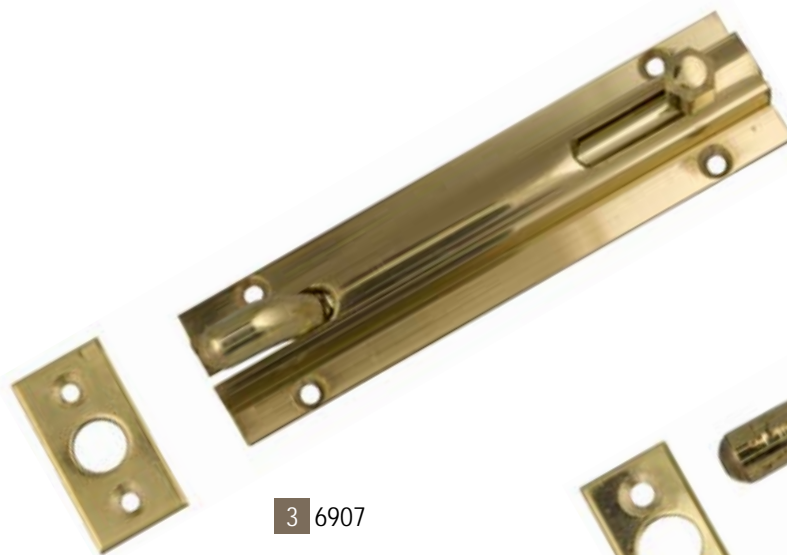

3 6907

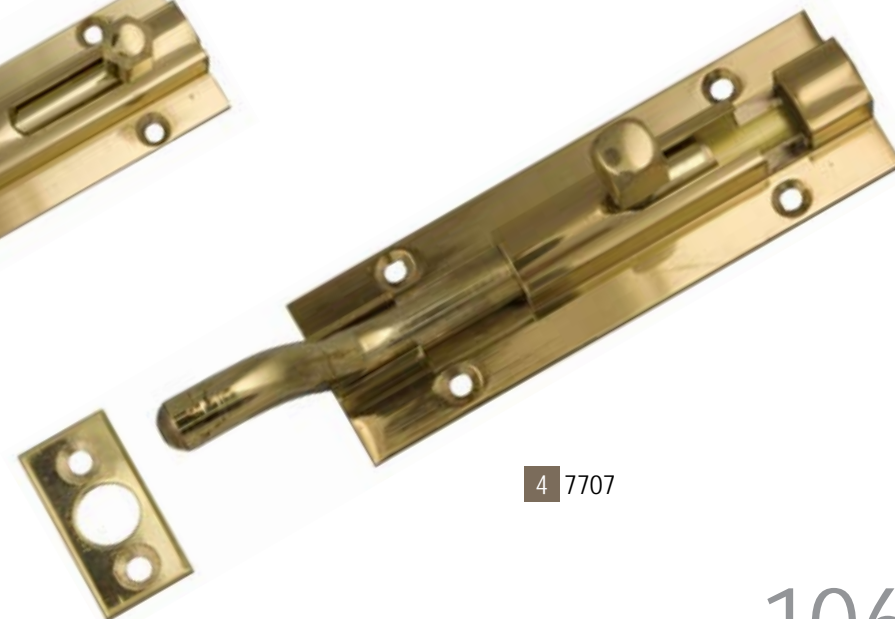

4 7707

# ARCHITECTURAL RIM LOCKS

Hand made Brass Rim Locks. Manufactured in Willenhall by skilled craftsmen from The Heart of The Black Country.

- All brass interior parts
- 2 Lever
- 2 brass plated steel keys per lock.
- Extended keys available to order
- Standard stock all to pass
- Note that handing of these locks is different to cabinet patterns.
- Please supply application drawings with order to ensure accurate supply.
- Specials undertaken and priced against detailed drawings.
- 10 warded differs available
- c/w all fixing screws
- Standard supply Polished Brass
- Other finishes available.



1 B1026



2 B1025



3 B1046



4 B1045

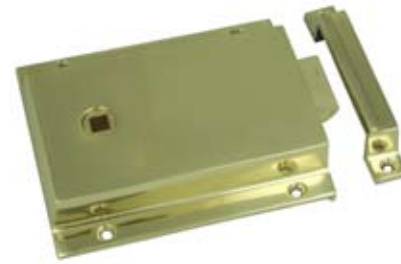

5 B1125



6 B1115



7 B1095



8 B1065

## Flanged Rim Lock (left hand illustrated)

Code	Size	Backset keyhole	Backset follower
1 B1026	152mm x 102mm	51mm	122mm
2 B1025	127mm x 102mm	40mm	98mm

## Unflanged Rim Lock (left hand illustrated)

Code	Size	Backset keyhole	Backset follower
3 B1046	152mm x 76mm	51mm	122mm
4 B1045	127mm x 76mm	40mm	98mm

## Flanged Rim Latch reversible

Code	Size	Backset to follower
B1126	152mm x 102mm	98mm
5 B1125	127mm x 102mm	120mm

## Unflanged Rim Latch reversible

Code	Size	Backset to follower
B1116	152mm x 76mm	98mm
6 B1115	127mm x 76mm	120mm

## 7 Flanged Bathroom Rim Latch (right hand illustrated)

Also available with emergency release.  
Shown in Polished Chrome  
(In application bolt would be below latch)

Code	Size
B1095	127mm x 102mm

## 8 Unflanged Bathroom Rim Lock (right hand illustrated)

Also available with emergency release.

Code	Size
B1065	127mm x 76mm

**1 Ball Knob Design for rim locks**

Code	Knob Diameter	Rose Diameter
H151	48mm	57mm

**2 Bun Knob Plain Design for rim locks**

Code	Knob Diameter	Rose Diameter
H152	51mm 57mm	57mm 64mm

**3 Oval Knob Design for rim locks**

Code	Knob diameter	Rose Diameter
H153	59 X 40mm	57mm

**4 Oval Knob**

Code	Knob Diameter	Rose Diameter
H251	68mm x 42mm	70mm

**5 Oval Knob**

Code	Knob Diameter	Rose Diameter
H252	59mm x 40mm	57mm

Also available with microtite spindle

**6 Oval Knob on Plate**

Code	Knob Diameter	Plate Diameter
H253	59mm x 40mm	50mm x 125mm

**7 Ball Knob Plain Design**

Code	Knob Diameter	Rose Diameter
H254	48mm	57mm

Also available with microtite spindle

**8 Ball Knob Reeded Design**

Code	Knob Diameter	Rose Diameter
H255	48mm	57mm

Also available with microtite spindle

**9 Plain Bun Design**

Code	Knob Diameter	Rose Diameter
H261	51mm 57mm 64mm	57mm 64mm 70mm

Also available with microtite spindle

**10 Stepped Bun Design**

Code	Knob Diameter	Rose Diameter
H262	51mm 57mm 64mm	57mm 64mm 70mm

Also available with microtite spindle

**11 Reeded Bun Design**

Code	Knob Diameter	Rose Diameter
H263	51mm 57mm 64mm	57mm 64mm 70mm

Also available with microtite spindle

**12 Stamped Reeded Design escutcheon with swing cover**

Code	Diameter
H301	31mm

**13 Stamped Pear Drop Design Escutcheon with swing cover**

Code	Height	Width
H302	59mm	19mm

**14 Stamped Plain Flat Design Escutcheon**

Code	Diameter
H303	32mm

Brass Knob Furniture (Patterns 1 - 3 inclusive for rim locks, 4 - 11 inclusive for mortice locks and latches)  
Locally sourced from our Birmingham Brassfoundry Partners

- Infinitely adjustable for doors between 35mm and 65mm thick
- All the pulling force transferred through the spindle
- No visible grubscrew
- Ideal for hollow core doors or those fitted with a closer



1 H151



2 H152



3 H153



4 H251



5 H252



6 H253



7 H254



8 H255



9 H261



10 H262



11 H263



12 H301



13 H302



14 H303

# ARCHITECTURAL DOOR STOPS AND FLUSH HANDLES

Door stops and flush handles  
All traditional and contemporary finishes available



## 1 Floor Mounted Door Stop

Code	Height	Width
H554	29mm	50mm

## 2 Floor Mounted Door Stop

Suitable for stepped thresholds and deep pile carpets

Code	Height	Width
H555	31mm	48mm

## 3 Skirting Board mounted Door Stop

Code	Diameter	Length
H551	42mm	51mm
	42mm	63mm
	42mm	76mm

## 4 Concealed Fix Projecting Door Stop

Code	Length
H750	65mm
	75mm

## 5 Face Fix Door Stop on Round Rose

Code	Length
H751	65mm
	75mm

## 6 Door Holder Door to wall Mounted

Automatic Latching and manual release

Code	Height	Overall Length
H552	57mm	87mm

## 7 Stamped Brass Flush Pull

Code	Height	Width
H311	90mm	41mm
	103mm	51mm

## 8 Stamped Brass Flush Pull

Code	Height	Width
H312	89mm	41mm

## 9 Stamped Brass Offset Flush Pull

Code	Height	Width
H313	114mm	64mm



Solid Brass Surface and flush Bolts  
All traditional and contemporary finishes available

## 1 Knob Slide Action Surface Bolt

Code Lengths available  
H471 100mm  
150mm  
200mm  
Shoot Size: 10 x 10mm  
Length of Throw: 20mm

## 2 Lever Action Surface Bolt

Code Lengths available  
H472 229mm  
305mm  
Shoot Size: 16 x 13mm  
Length of Throw: 16mm

## 3 Knob Slide Action Surface Bolt

Code Lengths available  
H473 200mm  
300mm  
Shoot Size: 13 x 13mm  
Length of Throw: 25mm

## 4 Sunk Slide Action Brass Flush Bolt

Code H484

Length	Width	Depth	Shoot dia	Throw length
76mm	13mm	12mm	6.3mm	9mm
102mm	16mm	13mm	6.3mm	12mm
152mm	19mm	16mm	9.5mm	15mm
152mm	25mm	18mm	11mm	15mm
229mm	25mm	18mm	11mm	15mm
305mm	25mm	18mm	11mm	15mm

## 5 Knob Slide Action Flush Bolt

Code Lengths available  
H481 152mm  
229mm  
305mm  
Shoot size: 11mm diameter  
Length of throw: 16mm  
Depth of mortice: 22mm  
Width: 25mm

## 6 Lever Action Flush Bolt

Corrosion Free Stainless Steel  
Available in Satin and Polished finish  
Smooth Easy action  
Round Ends

Code	Length
H482	250mm

Shoot size: 7.5mm diameter  
Length of throw: 16mm  
Depth of mortice: 15mm

## 7 Lever Action Brass Flush Bolt

Corrosion Free Stainless Steel  
Available in Satin or Polished Finish  
Smooth easy action  
Round ends

Code	Length
H483	250mm

Shoot size: 10mm diameter  
Length of throw: 17mm  
Depth of mortice: 24mm



# ARCHITECTURAL ESPAGNOLETTE BOLTS

- Solid Brass reversible (non-handed) Espagnolette Bolts
- Rack and Pinion Mechanism
- Solid Brass Construction
- Reversible for on-site handing and fitting
- Full fitting instructions included.

## HOW TO ORDER

These bolts are manufactured as standard to suit an opening of 2134mm ( 84" ).Should any other size be required please specify size when ordering ( i.e H803 2300mm )

## FRAME FIXING

All bolts are supplied with both staples and flat striking plates for inward opening doors and angle striking plates for outward opening doors.



### 1 Knob operation Bolt

Code	Height	Width
H801	128mm	30mm

Shoot size: 13 x 6mm

### 2 Lever operation Bolt

Code	Height	Width
H803	sizes as H801	

### 3 Knob operation Bolt

Code	Height	Width
H810	106mm	30mm

Shoot size: 10 x 10mm

### 4 Lever operation Bolt

Code	Height	Width
H811	sizes as H810	

### 5 Knob operation Bolt

Code	Height	Width
H808	155mm	42mm

Shoot size: 14 x 8mm

### 6 Lever operation Bolt

Code	Height	Width
H807	sizes as H808	

## 1 Knob operation Bolt

Code	Height	Width
H824	140mm	26mm
Shoot size 10 x 10mm		

## 2 Lever operation Bolt

Code	Height	Width
H822	140mm	26mm
Shoot size 10 x 10mm		

## 3 Lever operation Bolt

Fitted with 5 lever lock mechanism

Code	Height	Width
H836	170mm	46mm
Shoot size 14 x 8mm		

H836 with 5 lever locking mechanism are supplied to differ and with two keys. Please advise if locks are required to pass and if extra keys needed.

## 4 Locking Block

KEY OPERATION  
ADDS SECURITY

Simple to fit  
Complete with one key.

Code	Height	Width
H500	24mm	38mm

Fits H822, H824, H801, H807, H808, H810, H811.

## Espagnolette Bolts (Handed)

These bolts are handed.  
Manufactured to suit an opening of 2134mm (84")

Should any other size be required please specify when ordering.

Illustrations show H822 and H836 as left hand.

## FRAME FIXING

All bolts are supplied with both staples and flat striking plates for inward and opening doors and angle striking plates for outward opening doors.



1 H824



2 H822



3 H836



4 H500

# General Information

## Fixing Screws.

Wood screws of a matching finish are included with all of our surface mounted products. All other products are supplied complete with fastenings.



Please note that traditional furniture knobs are supplied either as (R/f) rear-fix with an M4 x 40mm machine screw or as a (W/s) woodscrew fixing with an M4 wood-metal dowel.

The traditional method of bolt & nut fixing is still available to special order.

## Non Standard Items.

We would also welcome enquiries for special items of brass hardware outside of our normal cabinet range. We have at our disposal a complete facility for the manufacture of components and finished products in brass, bronze, steel, and aluminium.

## Errors and Improvements.

We reserve the right to modify designs and dimensions for reason of design or manufacturing improvement. Every care has been taken to ensure the accuracy of information in this brochure; we cannot accept responsibility for errors or omissions.

## Units of Measure.

As the majority of the Armac range is reproduction antique fittings, and the patterns we used can be over 100 years old, it should be no surprise that the original measurements were Imperial. Armac have stayed true to the original sizes and specifications rather than try to adapt to 'more practical' sizing. Hence we still have 3.3/8" and 2.7/8" etc.

For the purpose of the catalogue we have decided to show the products with a metric measurement as this is now more universally the standard. We couldn't let the old imperial sizes disappear altogether though so the conversion is listed here for the purists (of which we like to include ourselves).

mm	inches	mm	inches	mm	inches
9mm	3/8"	60mm	2 3/8"	140mm	5 1/2"
13mm	1/2"	64mm	2 1/2"	146mm	5 3/4"
16mm	5/8"	70mm	2 3/4"	150mm	5 7/8"
19mm	3/4"	76mm	3"	152mm	6"
25mm	1"	82mm	3 1/4"	166mm	6 1/2"
28mm	1 1/8"	86mm	3 3/8"	178mm	7"
32mm	1 1/4"	89mm	3 1/2"	191mm	7 1/2"
34mm	1 5/16"	92mm	3 5/8"	203mm	8"
35mm	1 3/8"	95mm	3 3/4"	210mm	8 1/4"
38mm	1 1/2"	98mm	3 7/8"	229mm	9"
41mm	1 5/8"	102mm	4"	254mm	10"
45mm	1 3/4"	105mm	4 1/8"	266mm	10 1/2"
48mm	1 7/8"	108mm	4 1/4"	279mm	11"
51mm	2"	115mm	4 1/2"	292mm	11 1/2"
54mm	2 1/8"	121mm	4 3/4"	305mm	12"
57mm	2 1/4"	127mm	5"	327mm	12 1/2"

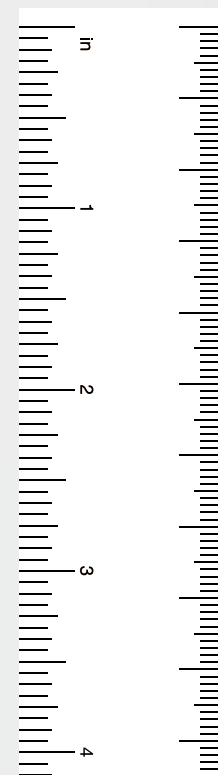

# Finishes

Antique and Polished Brass (ANT, POL) are the two original finishes of the Armac business and many items are still stocked and sold in this way. The Armac antique is quite like no-other, it can vary in shade and relief, and will tone down and patinate beautifully over time once fitted to the furniture. It is often copied but never equalled. The Polished Brass is always lacquered unless requested otherwise, and a highly durable Stove Lacquer is used that, unless wiped with kitchen cleaners or bleaches will probably outlast the furniture! More recently we have added Nickel and Chromium plating to several of the ranges both in the polished finish and a more brushed satin effect (PCP, PNP, SCP, SNP). Other finishes unique to Armac are the Old English Brass (OEB) and the Special Old Colour (SOC).

In addition to these 'standards' we are prepared to try and achieve any look you desire, and if it can be done to brass then we can do it! Gold plate, Black Gold, Silver Plate, or Antique Silver. Black Chrome or Dull Nickel. Light Antique, Dark Antique, Matt Antique, Matt Brass, Sanded Brass, Satin Brass, American Bronze, Rose Gold... The list goes on....



ANT – Antique Brass



MATT ANT – Matt Antique Brass



PNP – Polished Nickel plate



PCP – Polished Chrome Plate



ASP – Antique Silver Plate



SCP – Satin Chrome Plate



SOC – Special Old Colour



SAT – Satin Brass



OEB – Old English Brass



POL – Polished Brass



SNP – Satin Nickel Plate

# Conditions and terms of trading

## 1. General

All tenders and quotations are submitted and all orders accepted solely upon and subject to the following terms and conditions to the exclusion of all other terms and conditions except such (if any) as are specifically accepted by the company in writing. Acceptance of delivery shall be conclusive of acceptance of these terms and conditions.

## 2. Quotations

Quotations are submitted on the understanding that goods supplied will be liability invoiced at prices ruling at the date of despatch unless otherwise agreed.

## 3. Delivery Promises

These are given in good faith and will be adhered to, as far as possible, but no liability will be accepted for subsequent unforeseen delays. Goods offered ex-stock are subject to their being unsold on receipt of confirmation.

## 4. Cancellation and Variations

- (1) Cancellation of an order cannot be accepted, or goods returned for credit, unless previously agreed in writing by the company.
- (2) No variation of any order shall be binding upon the company unless the same shall be agreed in writing.
- (3) Stock items returned by agreement with the company shall be subject to a re-stocking charge.

## 5. Loss or Damage in Transit

Where goods are sent carriage paid the company will replace free of charge goods damaged or lost in transit provided that written notification is given to the company within three days of delivery or in case of total non-delivery notice is given to the carriers and the company within seven days of the date of notice of despatch.

## 6. Inspection

The customer shall inspect the goods immediately on arrival thereof and shall note shortages or damages on the delivery note and given written notice to the delivery, with full details of their claim, within seven days from such arrival. If the customer should fail to give such notice within the said period the goods shall be deemed to be in all respects in accordance with the contract and the customer shall be bound to accept and pay for them accordingly.

## 7. Retention Of Title

- (1) Risk in the goods shall pass to the customer immediately on delivery to the customer or into custody on the customer's behalf whichever is the sooner.
- (2) Notwithstanding delivery, the goods shall remain the property of the company (which reserves the right to dispose of this contract) until the company has received payment of the full price of (a) all goods the subject and (b) all other goods supplied by the company to the customer under any other contract whatsoever.

(3) The customer shall nevertheless be entitled to deal with the goods in the ordinary course of business provided that:

- (a) The customer shall not purport to dispose of property in the goods until delivery to its own customer.
- (b) The customer shall first dispose of the goods that it has paid for and any payments received by the company from the customer shall first be appropriated to goods disposed of by the company.
- (c) If the goods are altered or any goods become attached to the goods or if any part of the goods is replaced, such other goods or replacement parts shall accede to and form part of the goods and such attachment or replacement shall not affect the company's property in the goods.
- (4) Until the property in the goods passes to the customer the customer shall hold the goods as bailee for the company and shall store the goods in such a way that they are readily identifiable as the property of the company.
- (5) If payment of the price or any part of it under this or any other contract is overdue or if the customer is in breach of any contractual term of this, or any other contract with the company or if a receiver is appointed overall up or becomes bankrupt, then without notice:
  - (a) All sums payable by the customer to the company under this or any other contract shall become immediately due and payable.
  - (b) The customer shall cease to be entitled to sell, use in manufacture or otherwise deal with the goods.
  - (c) The company shall be entitled to recover and resell the goods (without prejudice to its right to damages) and for that purpose the customer hereby irrevocably grants the company its servants or agents a licence to enter upon the customer's premises for the purpose of removing the goods.
  - (d) The company shall be entitled to stop all further deliveries of goods to the customer under this or any other contract.
  - (e) If any of the forgoing provisions shall be invalid or unenforceable such invalidity or unenforceability shall not affect the remaining provisions.

## 8. Payment (Credit cards only)

Strictly Nett – Payment within one month following month of invoice.

## 9. Specification

In accordance with our policy of constant improvement we reserve the right to modify or amend without notice the specification of any of our products.

## 10. Liability

- (1) The company's liability whether in respect of one claim or in the aggregate arising out of any contract shall not exceed the purchase price payable under the contract
- (2) Except as specifically provided in these conditions, no liability is accepted for any direct or indirect costs, damages or expenses relating to damage to property or injury or loss to any person firm or company or for any loss of profits or production arising out of or occasioned by any defect in or failure of goods or materials or parts thereof supplied by the company.

## 11. Force Majeure

The company shall be under no liability for any delay, loss or damage caused wholly or in part by the Act of God, Governmental restriction condition or control or by reason of any act done or not done pursuant to a trade dispute whether such dispute involves the company's employees or not or by reason of any other act matter or thing beyond the reasonable control of the company.

## 12. Law Applicable

All contracts are deemed to be entered into England and shall be governed and constructed in accordance with English Law.

07/20

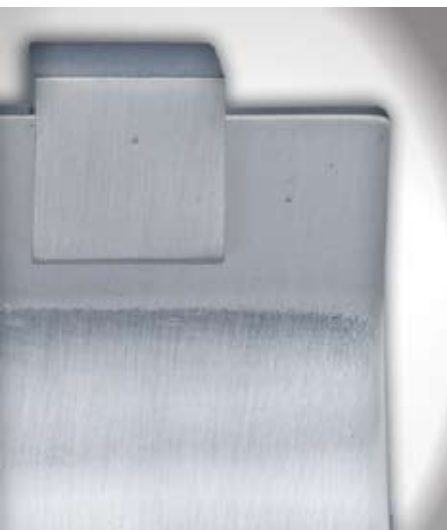

*martin*  
Furniture and interior fittings

160 Dollman Street, Duddeston, Birmingham, B7 4RS, UK

Tel: + 44 (0) 121 359 2111

Fax: + 44 (0) 121 359 4698

Email [sales@martin.co.uk](mailto:sales@martin.co.uk)

[www.martin.co.uk](http://www.martin.co.uk)